

# SILICON POWER TRANSISTOR 2SD2165

### NPN SILICON EPITAXIAL TRANSISTOR FOR LOW-FREQUENCY POWER AMPLIFIERS AND LOW-SPEED SWITCHING

The 2SD2165 is a single power transistor developed especially for high  $h_{FE}$ . This transistor is ideal for simplifying drive circuits and reducing power dissipation because its  $h_{FE}$  is as high as that of Darlington transistors, but it is a single transistor.

In addition, this transistor features a small resin-molded insulation package, thus contributing to high-density mounting and mounting cost reduction.

#### FEATURES

- High  $h_{FE}$  and low  $V_{CE(sat)}$ :  
 $h_{FE} \cong 1,300$  TYP. ( $V_{CE} = 5.0$  V,  $I_C = 1.0$  A)  
 $V_{CE(sat)} \cong 0.3$  V TYP. ( $I_C = 3.0$  A,  $I_B = 30$  mA)
- Mold package that does not require an insulating board or insulation bushing

#### ABSOLUTE MAXIMUM RATINGS ( $T_A = 25^\circ\text{C}$ )

Parameter	Symbol	Ratings	Unit
Collector to base voltage	$V_{CBO}$	100	V
Collector to emitter voltage	$V_{CEO}$	100	V
Emitter to base voltage	$V_{EBO}$	7.0	V
Collector current (DC)	$I_{C(DC)}$	6.0	A
Collector current (pulse)	$I_{C(pulse)}$	10 <sup>Note</sup>	A
Base current (DC)	$I_{B(DC)}$	1.0	A
Total power dissipation ( $T_C = 25^\circ\text{C}$ )	$P_T$	30	W
Total power dissipation ( $T_A = 25^\circ\text{C}$ )	$P_T$	2.0	W
Junction temperature	$T_j$	150	$^\circ\text{C}$
Storage temperature	$T_{stg}$	-55 to +150	$^\circ\text{C}$

**Note**  $PW \leq 300 \mu\text{s}$ , duty cycle  $\leq 10\%$

#### PACKAGE DRAWING (UNIT: mm)

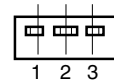
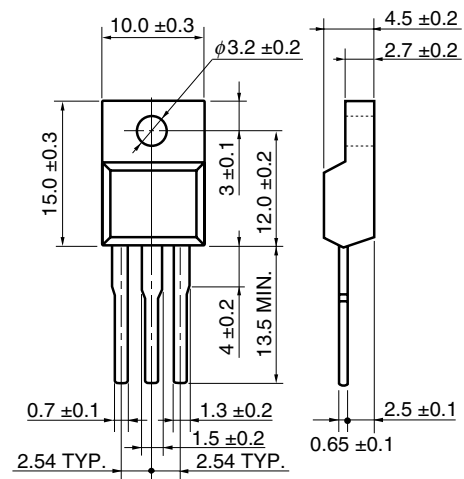

- Electrode Connection
1. Base
  2. Collector
  3. Emitter

The information in this document is subject to change without notice. Before using this document, please confirm that this is the latest version.  
 Not all products and/or types are available in every country. Please check with an NEC Electronics sales representative for availability and additional information.

**ELECTRICAL CHARACTERISTICS (T<sub>A</sub> = 25°C)**

Parameter	Symbol	Conditions	MIN.	TYP.	MAX.	Unit
Collector cutoff current	I <sub>CBO</sub>	V <sub>CB</sub> = 60 V, I <sub>E</sub> = 0 A			10	μA
Emitter cutoff current	I <sub>EBO</sub>	V <sub>EB</sub> = 7.0 V, I <sub>C</sub> = 0 A			10	μA
DC current gain	h <sub>FE1</sub>	V <sub>CE</sub> = 5.0 V, I <sub>C</sub> = 1.0 A <sup>Note</sup>	800	1,300	3,200	
DC current gain	h <sub>FE2</sub>	V <sub>CE</sub> = 5.0 V, I <sub>C</sub> = 3.0 A <sup>Note</sup>	500	1,000		
★ Collector saturation voltage	V <sub>CE(sat)</sub>	I <sub>C</sub> = 3.0 A, I <sub>B</sub> = 30 mA <sup>Note</sup>		0.3	1.0	V
Base saturation voltage	V <sub>BE(sat)</sub>	I <sub>C</sub> = 3.0 A, I <sub>B</sub> = 30 mA <sup>Note</sup>			1.2	V
Gain bandwidth product	f <sub>T</sub>	V <sub>CE</sub> = 5.0 V, I <sub>C</sub> = 0.1 A		110		MHz
Collector capacitance	C <sub>ob</sub>	V <sub>CB</sub> = 10 V, I <sub>E</sub> = 0 A, f = 1.0 MHz		50		pF

**Note** Pulse test PW ≤ 350 μs, duty cycle ≤ 2%

**h<sub>FE1</sub> CLASSIFICATION**

Marking	M	L	K
h <sub>FE1</sub>	800 to 1,600	1,000 to 2,000	1,600 to 3,200

TYPICAL CHARACTERISTICS (T<sub>A</sub> = 25°C)

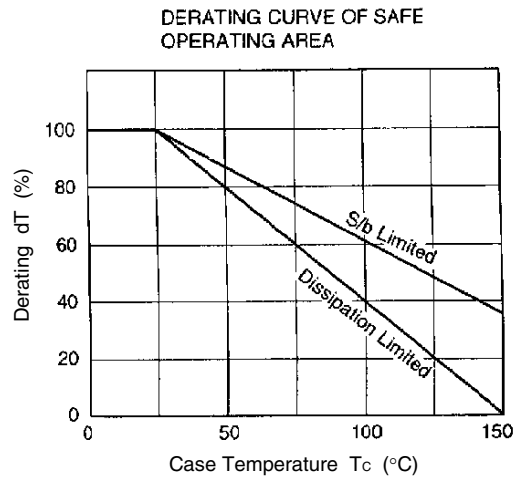
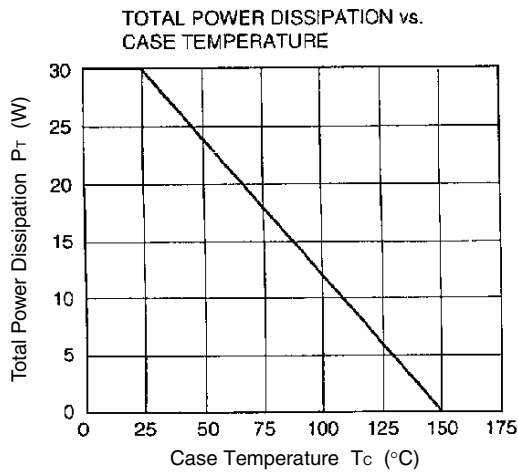

FORWARD BIAS SAFE OPERATING AREA

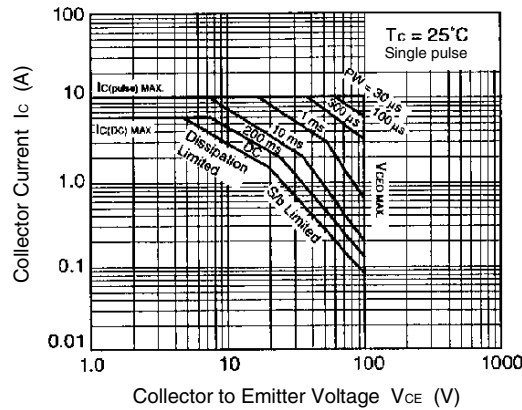

TRANSIENT THERMAL RESISTANCE vs. PULSE WIDTH

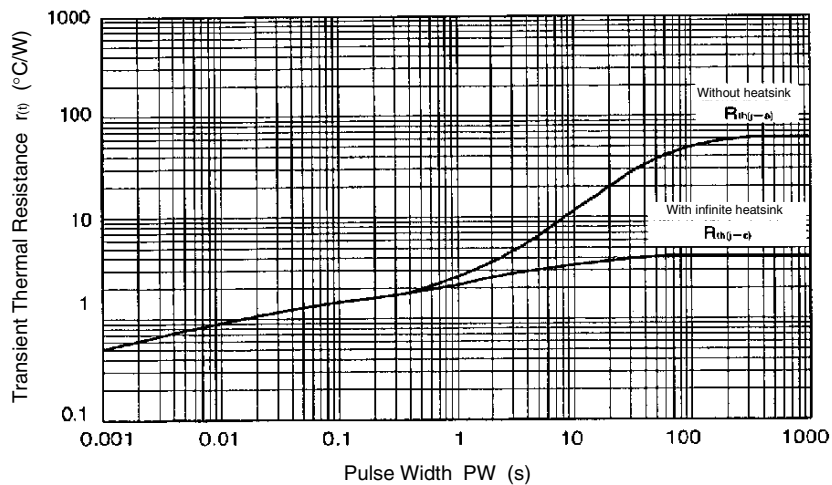

COLLECTOR CURRENT vs. COLLECTOR TO EMITTER VOLTAGE

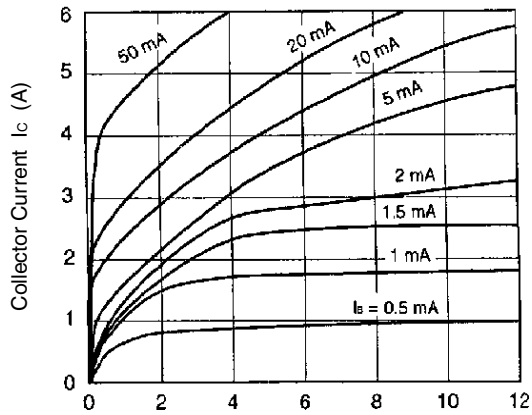

Collector to Emitter Voltage  $V_{CE}$  (V)

DC CURRENT GAIN vs. COLLECTOR CURRENT

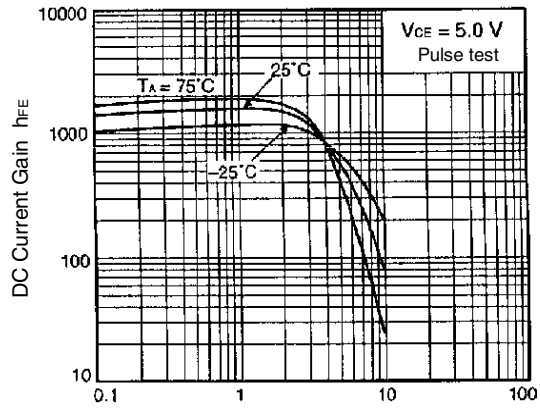

Collector Current  $I_c$  (A)

COLLECTOR AND BASE SATURATION VOLTAGE vs. COLLECTOR CURRENT

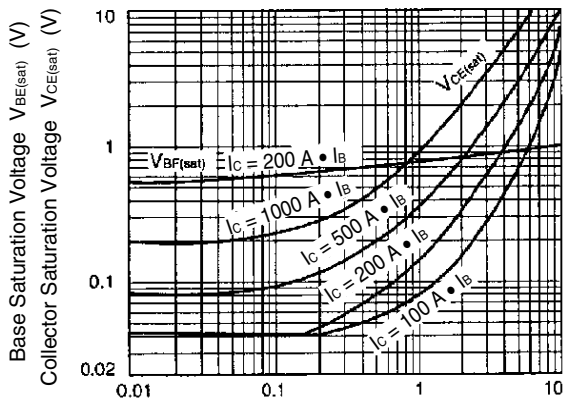

Collector Current  $I_c$  (A)

GAIN BANDWIDTH PRODUCT vs. COLLECTOR CURRENT

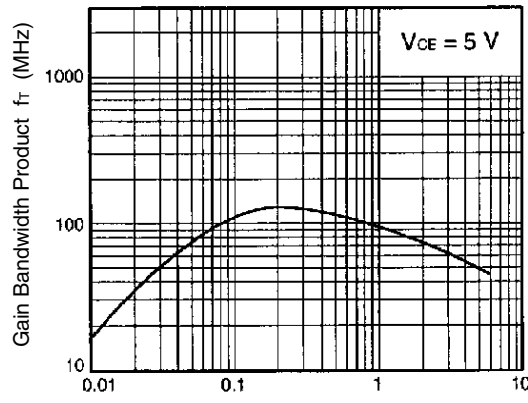

Collector Current  $I_c$  (A)

OUTPUT CAPACITANCE vs. COLLECTOR TO BASE VOLTAGE

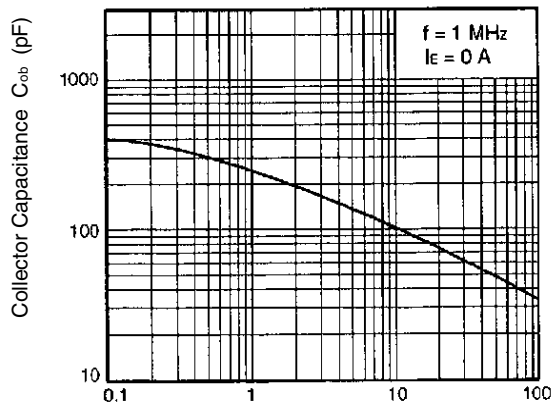

Collector to Base Voltage  $V_{CB}$  (V)

- **The information in this document is current as of March, 2004. The information is subject to change without notice. For actual design-in, refer to the latest publications of NEC Electronics data sheets or data books, etc., for the most up-to-date specifications of NEC Electronics products. Not all products and/or types are available in every country. Please check with an NEC Electronics sales representative for availability and additional information.**
- No part of this document may be copied or reproduced in any form or by any means without the prior written consent of NEC Electronics. NEC Electronics assumes no responsibility for any errors that may appear in this document.
- NEC Electronics does not assume any liability for infringement of patents, copyrights or other intellectual property rights of third parties by or arising from the use of NEC Electronics products listed in this document or any other liability arising from the use of such products. No license, express, implied or otherwise, is granted under any patents, copyrights or other intellectual property rights of NEC Electronics or others.
- Descriptions of circuits, software and other related information in this document are provided for illustrative purposes in semiconductor product operation and application examples. The incorporation of these circuits, software and information in the design of a customer's equipment shall be done under the full responsibility of the customer. NEC Electronics assumes no responsibility for any losses incurred by customers or third parties arising from the use of these circuits, software and information.
- While NEC Electronics endeavors to enhance the quality, reliability and safety of NEC Electronics products, customers agree and acknowledge that the possibility of defects thereof cannot be eliminated entirely. To minimize risks of damage to property or injury (including death) to persons arising from defects in NEC Electronics products, customers must incorporate sufficient safety measures in their design, such as redundancy, fire-containment and anti-failure features.
- NEC Electronics products are classified into the following three quality grades: "Standard", "Special" and "Specific".

The "Specific" quality grade applies only to NEC Electronics products developed based on a customer-designated "quality assurance program" for a specific application. The recommended applications of an NEC Electronics product depend on its quality grade, as indicated below. Customers must check the quality grade of each NEC Electronics product before using it in a particular application.

"Standard": Computers, office equipment, communications equipment, test and measurement equipment, audio and visual equipment, home electronic appliances, machine tools, personal electronic equipment and industrial robots.

"Special": Transportation equipment (automobiles, trains, ships, etc.), traffic control systems, anti-disaster systems, anti-crime systems, safety equipment and medical equipment (not specifically designed for life support).

"Specific": Aircraft, aerospace equipment, submersible repeaters, nuclear reactor control systems, life support systems and medical equipment for life support, etc.

The quality grade of NEC Electronics products is "Standard" unless otherwise expressly specified in NEC Electronics data sheets or data books, etc. If customers wish to use NEC Electronics products in applications not intended by NEC Electronics, they must contact an NEC Electronics sales representative in advance to determine NEC Electronics' willingness to support a given application.

(Note)

(1) "NEC Electronics" as used in this statement means NEC Electronics Corporation and also includes its majority-owned subsidiaries.

(2) "NEC Electronics products" means any product developed or manufactured by or for NEC Electronics (as defined above).

This datasheet has been download from:

[www.datasheetcatalog.com](http://www.datasheetcatalog.com)

Datasheets for electronics components.