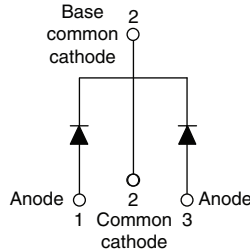

## High Performance Schottky Generation 5.0, 2 x 15 A

**TO-220AB**

**FEATURES**

- 175 °C high performance Schottky diode
- Very low forward voltage drop
- Extremely low reverse leakage
- Optimized  $V_F$  vs.  $I_F$  trade off for high efficiency
- Increased ruggedness for reverse avalanche capability
- RBSOA available
- Negligible switching losses
- Submicron trench technology
- Full lead (Pb)-free and RoHS compliant devices
- Designed and qualified for industrial level

**RoHS  
COMPLIANT**
**PRODUCT SUMMARY**

$I_{F(AV)}$	2 x 15 A
$V_R$	100 V
$V_F$ at 15 A at 125 °C	0.67 V

**APPLICATIONS**

- High efficiency SMPS
- Automotive
- High frequency switching
- Output rectification
- Reverse battery protection
- Freewheeling
- Dc-to-dc systems
- Increased power density systems

**MAJOR RATINGS AND CHARACTERISTICS**

SYMBOL	CHARACTERISTICS	VALUES	UNITS
$V_{RRM}$		100	V
$V_F$	15 Apk, $T_J = 125$ °C (typical, per leg)	0.63	
$T_J$	Range	- 55 to 175	°C

**VOLTAGE RATINGS**

PARAMETER	SYMBOL	TEST CONDITIONS	30CTT100	UNITS
Maximum DC reverse voltage	$V_R$	$T_J = 25$ °C	100	V

**ABSOLUTE MAXIMUM RATINGS**

PARAMETER	SYMBOL	TEST CONDITIONS	VALUES	UNITS
Maximum average forward current <small>per leg</small> <small>per device</small>	$I_{F(AV)}$	50 % duty cycle at $T_C = 144$ °C, rectangular waveform	15	A
			30	
Maximum peak one cycle non-repetitive surge current per leg	$I_{FSM}$	5 $\mu$ s sine or 3 $\mu$ s rect. pulse	920	
		10 ms sine or 6 ms rect. pulse	240	
Non-repetitive avalanche energy per leg	$E_{AS}$	$T_J = 25$ °C, $I_{AS} = 1.1$ A, L = 60 mH	36	mJ
Repetitive avalanche current per leg	$I_{AR}$	Limited by frequency of operation and time pulse duration so that $T_J < T_J$ max. $I_{AS}$ at $T_J$ max. as a function of time pulse See fig. 8	$I_{AS}$ at $T_J$ max.	A

ELECTRICAL SPECIFICATIONS						
PARAMETER	SYMBOL	TEST CONDITIONS		TYP.	MAX.	UNITS
Forward voltage drop per leg	$V_{FM}^{(1)}$	15 A	$T_J = 25\text{ }^\circ\text{C}$	-	0.81	V
		30 A		-	0.92	
		15 A	$T_J = 125\text{ }^\circ\text{C}$	-	0.67	
		30 A		-	0.79	
Reverse leakage current per leg	$I_{RM}^{(1)}$	$T_J = 25\text{ }^\circ\text{C}$	$V_R = \text{Rated } V_R$	-	120	$\mu\text{A}$
		$T_J = 125\text{ }^\circ\text{C}$		-	5	mA
Junction capacitance per leg	$C_T$	$V_R = 5\text{ }V_{DC}$ (test signal range 100 kHz to 1 MHz) $25\text{ }^\circ\text{C}$		550	-	pF
Series inductance per leg	$L_S$	Measured lead to lead 5 mm from package body		8.0	-	nH
Maximum voltage rate of change	dV/dt	Rated $V_R$		-	10 000	V/ $\mu\text{s}$

**Note**(1) Pulse width < 300  $\mu\text{s}$ , duty cycle < 2 %

THERMAL - MECHANICAL SPECIFICATIONS				
PARAMETER	SYMBOL	TEST CONDITIONS	VALUES	UNITS
Maximum junction and storage temperature range	$T_J, T_{Stg}$		- 55 to 175	$^\circ\text{C}$
Maximum thermal resistance, junction to case per leg	$R_{thJC}$	DC operation	2.5	$^\circ\text{C/W}$
Maximum thermal resistance, junction to case per device			1.25	
Typical thermal resistance, case to heatsink	$R_{thCS}$	Mounting surface, smooth and greased	0.5	
Approximate weight			2	g
			0.07	oz.
Mounting torque	minimum		6 (5)	kgf · cm (lbf · in)
	maximum		12 (10)	
Marking device		Case style TO-220AB	30CTT100	

High Performance  
Schottky Generation 5.0,  
2 x 15 A

Vishay High Power Products

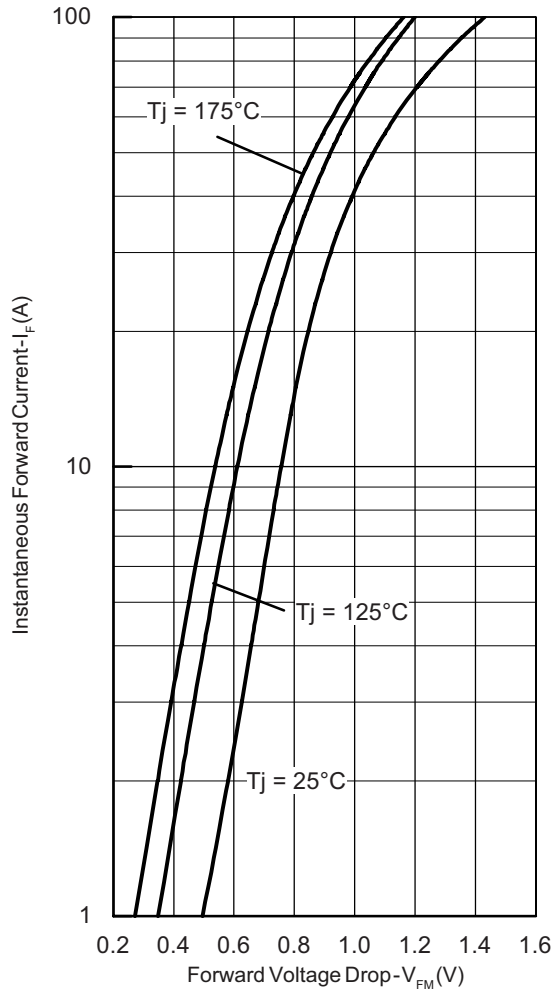

Fig. 1 - Maximum Forward Voltage Drop Characteristics

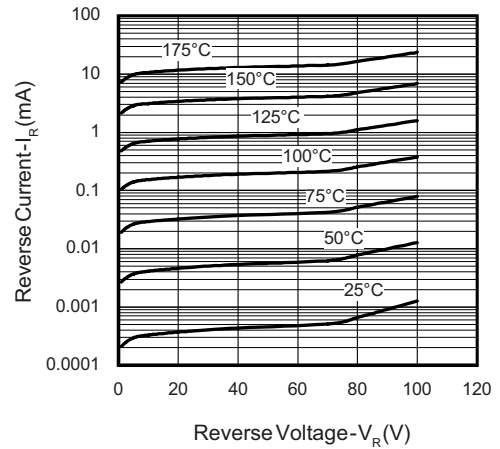

Fig. 2 - Typical Values of Reverse Current vs. Reverse Voltage

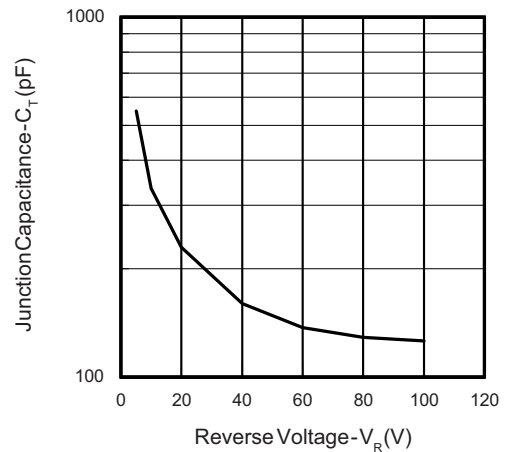

Fig. 3 - Typical Junction Capacitance vs. Reverse Voltage

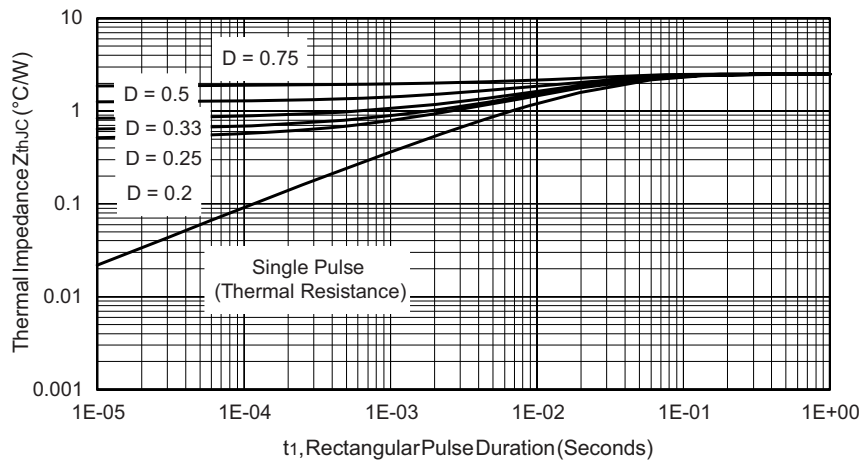

Fig. 4 - Maximum Thermal Impedance  $Z_{thJC}$  Characteristics

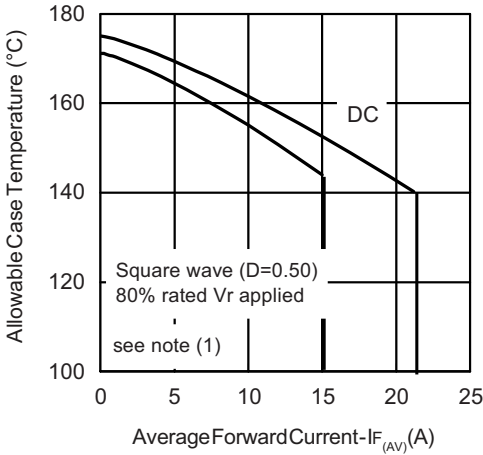

Fig. 5 - Maximum Allowable Case Temperature vs. Average Forward Current

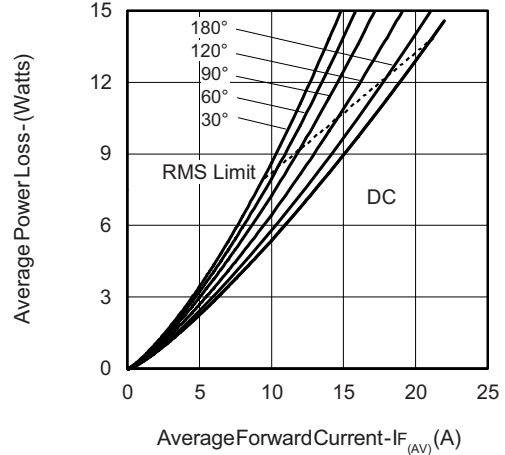

Fig. 6 - Forward Power Loss Characteristics

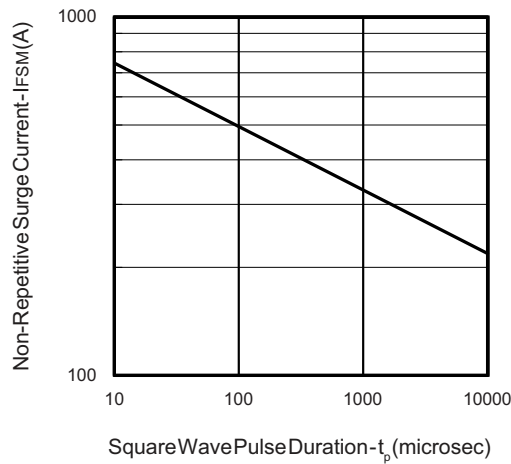

Fig. 7 - Maximum Non-Repetitive Surge Current

**Note**

- (1) Formula used:  $T_C = T_J - (P_d + P_{d_{REV}}) \times R_{thJC}$ ;  
 $P_d = \text{Forward power loss} = I_{F(AV)} \times V_{FM} \text{ at } (I_{F(AV)}/D)$  (see fig. 6);  
 $P_{d_{REV}} = \text{Inverse power loss} = V_{R1} \times I_R (1 - D)$ ;  $I_R$  at  $V_{R1} = 80\%$  rated  $V_R$

High Performance Schottky Generation 5.0, 2 x 15 A Vishay High Power Products

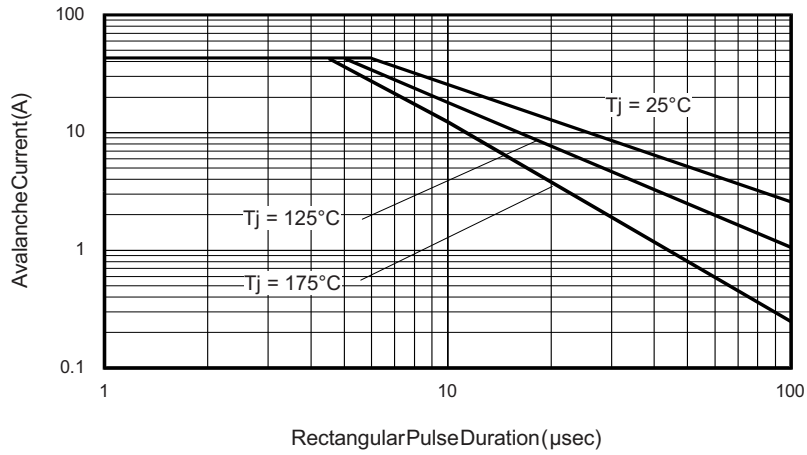

Fig. 8 - Reverse Bias Safe Operating Area (Avalanche Current vs. Rectangular Pulse Duration)

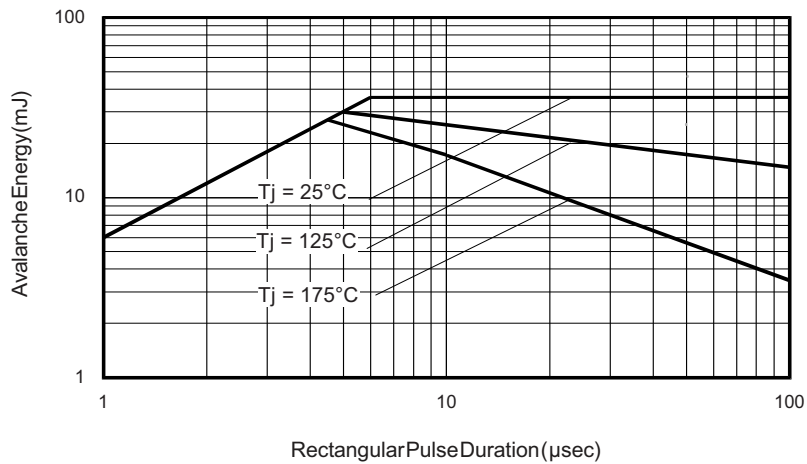

Fig. 9 - Reverse Bias Safe Operating Area (Avalanche Energy vs. Rectangular Pulse Duration)

# 30CTT100



Vishay High Power Products

High Performance  
Schottky Generation 5.0,  
2 x 15 A

## ORDERING INFORMATION TABLE

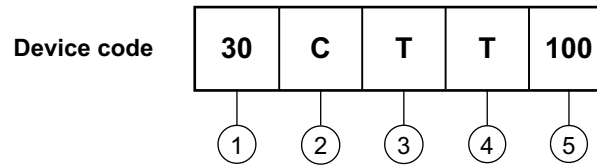

- 1** - Current rating (30 A)
- 2** - Circuit configuration:  
C = Common cathode
- 3** - Package:  
T = TO-220
- 4** - T = Trench
- 5** - Voltage code (100 V)

Tube standard pack quantity: 50 pieces

LINKS TO RELATED DOCUMENTS	
Dimensions	<a href="http://www.vishay.com/doc?95222">http://www.vishay.com/doc?95222</a>
Part marking information	<a href="http://www.vishay.com/doc?95225">http://www.vishay.com/doc?95225</a>

## TO-220AB

**DIMENSIONS** in millimeters and inches

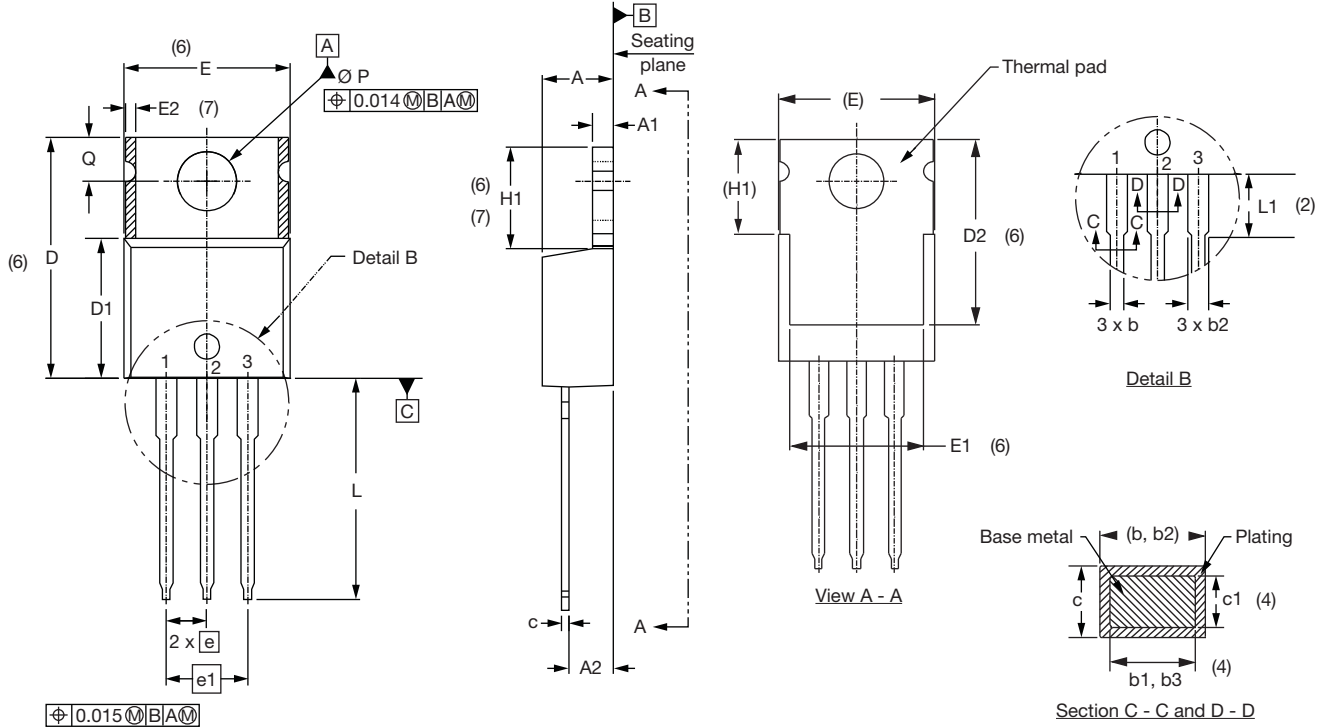

**Lead assignments**

Diodes

- 1. - Anode/open
- 2. - Cathode
- 3. - Anode

Conforms to JEDEC outline TO-220AB

SYMBOL	MILLIMETERS		INCHES		NOTES
	MIN.	MAX.	MIN.	MAX.	
A	4.25	4.65	0.167	0.183	
A1	1.14	1.40	0.045	0.055	
A2	2.56	2.92	0.101	0.115	
b	0.69	1.01	0.027	0.040	
b1	0.38	0.97	0.015	0.038	4
b2	1.20	1.73	0.047	0.068	
b3	1.14	1.73	0.045	0.068	4
c	0.36	0.61	0.014	0.024	
c1	0.36	0.56	0.014	0.022	4
D	14.85	15.25	0.585	0.600	3
D1	8.38	9.02	0.330	0.355	
D2	11.68	12.88	0.460	0.507	6

SYMBOL	MILLIMETERS		INCHES		NOTES
	MIN.	MAX.	MIN.	MAX.	
E	10.11	10.51	0.398	0.414	3, 6
E1	6.86	8.89	0.270	0.350	6
E2	-	0.76	-	0.030	7
e	2.41	2.67	0.095	0.105	
e1	4.88	5.28	0.192	0.208	
H1	6.09	6.48	0.240	0.255	6, 7
L	13.52	14.02	0.532	0.552	
L1	3.32	3.82	0.131	0.150	2
Ø P	3.54	3.73	0.139	0.147	
Q	2.60	3.00	0.102	0.118	
θ	90° to 93°		90° to 93°		

**Notes**

- (1) Dimensioning and tolerancing as per ASME Y14.5M-1994
- (2) Lead dimension and finish uncontrolled in L1
- (3) Dimension D, D1 and E do not include mold flash. Mold flash shall not exceed 0.127 mm (0.005") per side. These dimensions are measured at the outermost extremes of the plastic body
- (4) Dimension b1, b3 and c1 apply to base metal only
- (5) Controlling dimensions: inches
- (6) Thermal pad contour optional within dimensions E, H1, D2 and E1
- (7) Dimensions E2 x H1 define a zone where stamping and singulation irregularities are allowed
- (8) Outline conforms to JEDEC TO-220, except A2 (maximum) and D2 (minimum) where dimensions are derived from the actual package outline



## Disclaimer

ALL PRODUCT, PRODUCT SPECIFICATIONS AND DATA ARE SUBJECT TO CHANGE WITHOUT NOTICE TO IMPROVE RELIABILITY, FUNCTION OR DESIGN OR OTHERWISE.

Vishay Intertechnology, Inc., its affiliates, agents, and employees, and all persons acting on its or their behalf (collectively, "Vishay"), disclaim any and all liability for any errors, inaccuracies or incompleteness contained in any datasheet or in any other disclosure relating to any product.

Vishay makes no warranty, representation or guarantee regarding the suitability of the products for any particular purpose or the continuing production of any product. To the maximum extent permitted by applicable law, Vishay disclaims (i) any and all liability arising out of the application or use of any product, (ii) any and all liability, including without limitation special, consequential or incidental damages, and (iii) any and all implied warranties, including warranties of fitness for particular purpose, non-infringement and merchantability.

Statements regarding the suitability of products for certain types of applications are based on Vishay's knowledge of typical requirements that are often placed on Vishay products in generic applications. Such statements are not binding statements about the suitability of products for a particular application. It is the customer's responsibility to validate that a particular product with the properties described in the product specification is suitable for use in a particular application. Parameters provided in datasheets and/or specifications may vary in different applications and performance may vary over time. All operating parameters, including typical parameters, must be validated for each customer application by the customer's technical experts. Product specifications do not expand or otherwise modify Vishay's terms and conditions of purchase, including but not limited to the warranty expressed therein.

Except as expressly indicated in writing, Vishay products are not designed for use in medical, life-saving, or life-sustaining applications or for any other application in which the failure of the Vishay product could result in personal injury or death. Customers using or selling Vishay products not expressly indicated for use in such applications do so at their own risk. Please contact authorized Vishay personnel to obtain written terms and conditions regarding products designed for such applications.

No license, express or implied, by estoppel or otherwise, to any intellectual property rights is granted by this document or by any conduct of Vishay. Product names and markings noted herein may be trademarks of their respective owners.

## Material Category Policy

**Vishay Intertechnology, Inc. hereby certifies that all its products that are identified as RoHS-Compliant fulfill the definitions and restrictions defined under Directive 2011/65/EU of The European Parliament and of the Council of June 8, 2011 on the restriction of the use of certain hazardous substances in electrical and electronic equipment (EEE) - recast, unless otherwise specified as non-compliant.**

**Please note that some Vishay documentation may still make reference to RoHS Directive 2002/95/EC. We confirm that all the products identified as being compliant to Directive 2002/95/EC conform to Directive 2011/65/EU.**

**Vishay Intertechnology, Inc. hereby certifies that all its products that are identified as Halogen-Free follow Halogen-Free requirements as per JEDEC JS709A standards. Please note that some Vishay documentation may still make reference to the IEC 61249-2-21 definition. We confirm that all the products identified as being compliant to IEC 61249-2-21 conform to JEDEC JS709A standards.**