

SM2LZ47

AC POWER CONTROL APPLICATIONS

- Repetitive Peak Off-State Voltage : $V_{DRM} = 800V$
- R.M.S. On-State Current : $I_T (RMS) = 2A$
- High Commutation (dv / dt) : $(dv / dt) c = 5V / \mu s$ (Min.)
- Isolation Voltage : $V_{ISOL} = 1500V$ AC

MAXIMUM RATINGS

CHARACTERISTIC	SYMBOL	RATING	UNIT
Repetitive Peak Off-State Voltage	V_{DRM}	800	V
R.M.S. On-State Current (Full Sine Waveform)	$I_T (RMS)$	2	A
Peak One Cycle Surge On-State Current (Non-Repetitive)	I_{TSM}	8 (50Hz)	A
		8.8 (60Hz)	
I^2t Limit Value	I^2t	0.32	A^2s
Critical Rate of Rise of On-State Current (Note)	di / dt	50	A / μs
Peak Gate Power Dissipation	P_{GM}	3	W
Average Gate Power Dissipation	$P_G (AV)$	0.3	W
Peak Gate Voltage	V_{FGM}	10	V
Peak Gate Current	I_{GM}	1.6	A
Junction Temperature	T_j	-40~125	°C
Storage Temperature Range	T_{stg}	-40~125	°C
Isolation Voltage (AC, t = 1min.)	V_{ISOL}	1500	V

Note: di / dt test condition
 $V_{DRM} = 400V, I_{TM} \leq 3A, t_{gw} \geq 10\mu s, t_{gr} \leq 250ns, i_{gp} = I_{GT} \times 2.0$

Unit: mm

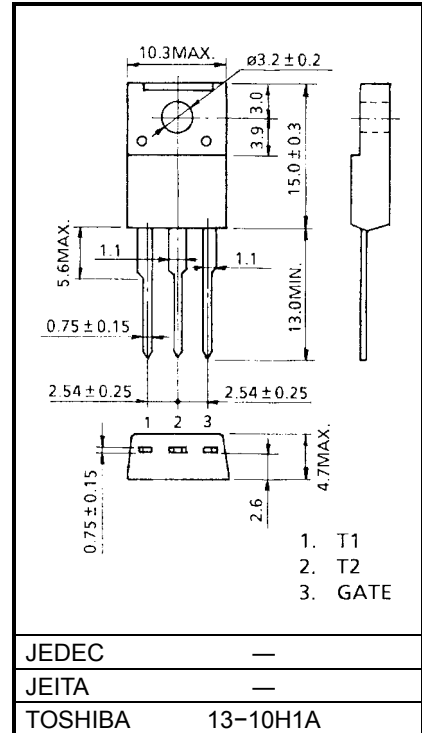

Weight: 1.7g

ELECTRICAL CHARACTERISTICS (Ta = 25°C)

CHARACTERISTIC	SYMBOL	TEST CONDITION	MIN	TYP.	MAX	UNIT	
Repetitive Peak Off-State Current	I_{DRM}	$V_{DRM} = 800V$	—	—	20	μA	
Gate Trigger Voltage	I	$V_D = 12V,$ $R_L = 20\Omega$	T2 (+), Gate (+)		—	1.5	V
	II		T2 (+), Gate (-)		—	1.5	
	III		T2 (-), Gate (-)		—	1.5	
Gate Trigger Current	I	$V_D = 12V,$ $R_L = 20\Omega$	T2 (+), Gate (+)		—	10	mA
	II		T2 (+), Gate (-)		—	10	
	III		T2 (-), Gate (-)		—	10	
Peak On-State Voltage	V_{TM}	$I_{TM} = 3A$	—	—	2.0	V	
Gate Non-Trigger Voltage	V_{GD}	$V_D = 800V, T_c = 125^\circ C$	0.2	—	—	V	
Holding Current	I_H	$V_D = 12V, I_{TM} = 1A$	—	—	10	mA	
Thermal Resistance	$R_{th(j-a)}$	Junction to Ambient, AC	—	—	58	$^\circ C / W$	
Critical Rate of Rise of Off-State Voltage	dv / dt	$V_{DRM} = 800V, T_j = 125^\circ C$ Exponential Rise	—	500	—	$V / \mu s$	
Critical Rate of Rise of Off-State Voltage at Communication	$(dv / dt)_c$	$V_{DRM} = 400V, T_j = 125^\circ C$ $(di / dt)_c = -0.5A / ms$	5	—	—	$V / \mu s$	

MARKING

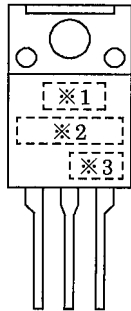

NUMBER	SYMBOL	MARK
*1	Toshiba Product Mark	
*2	TYPE	SM2LZ47
*3	Lot Number 	Example 8A : January 1998 8B : February 1998 8L : December 1998

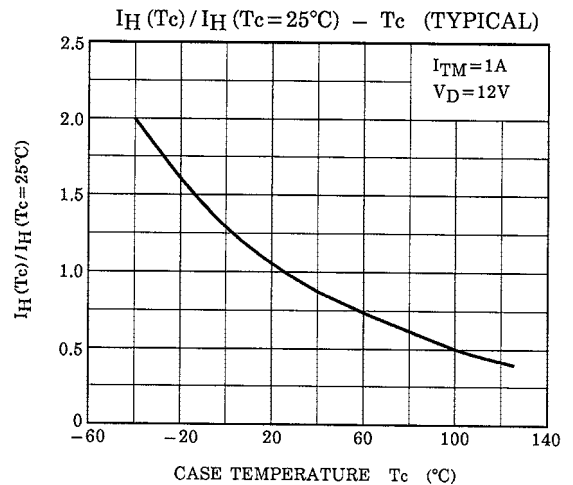
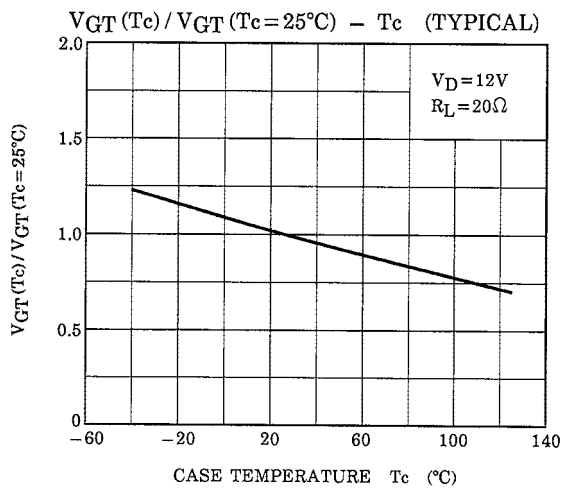
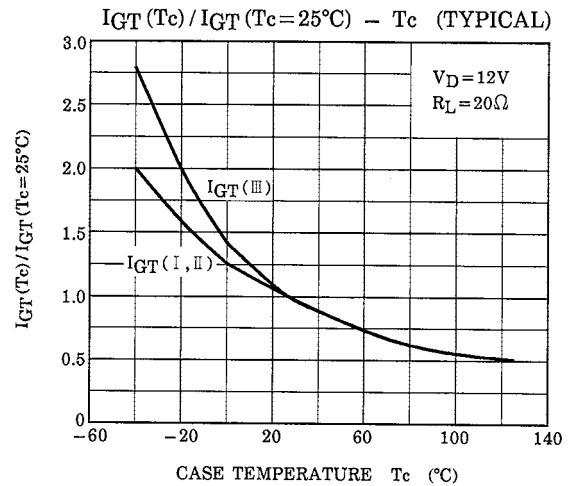
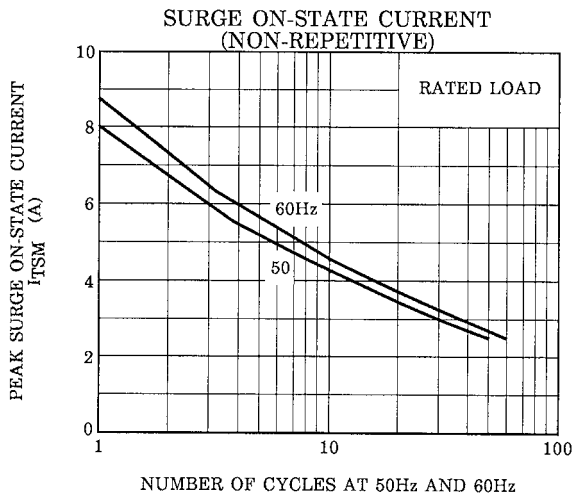
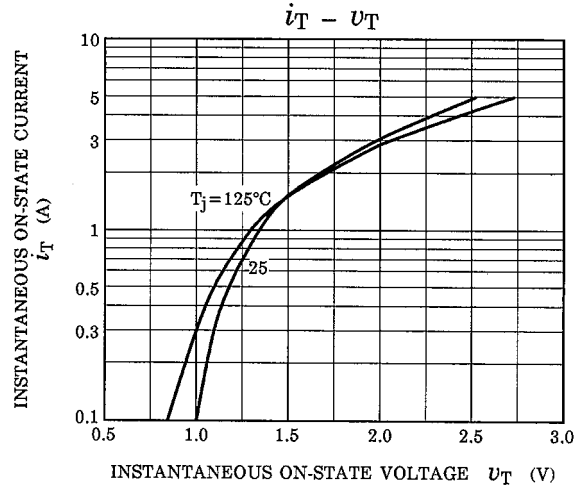
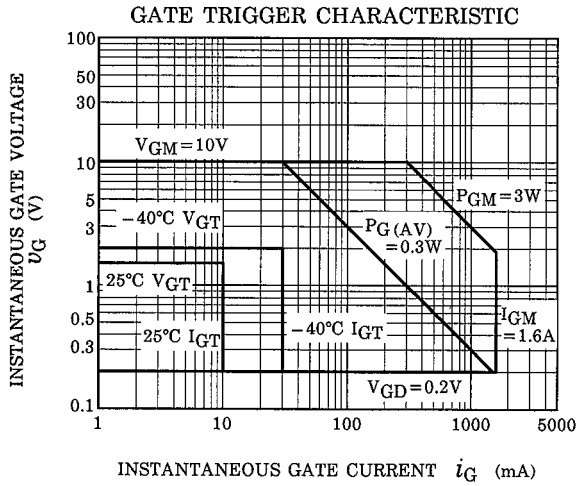

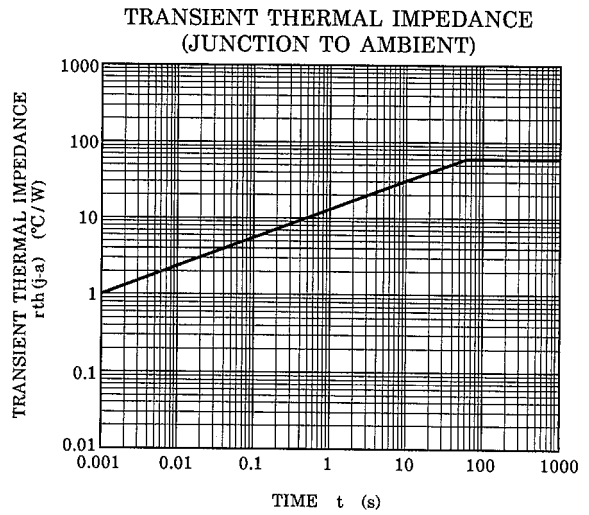
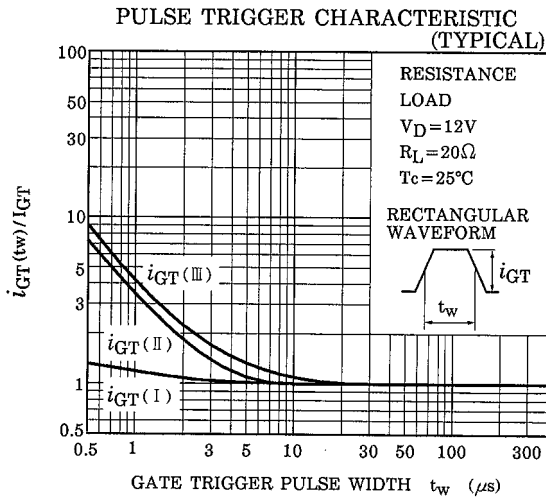
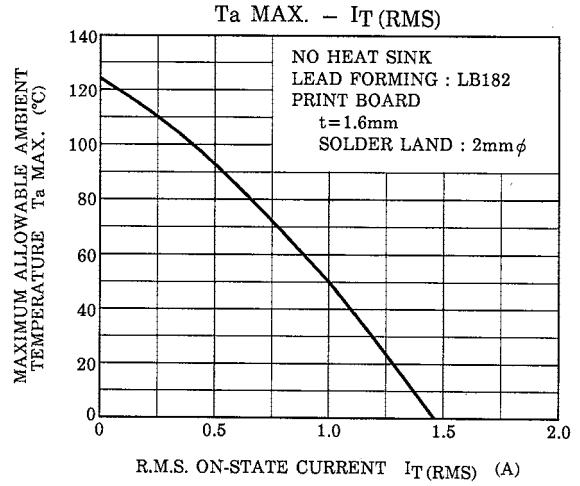
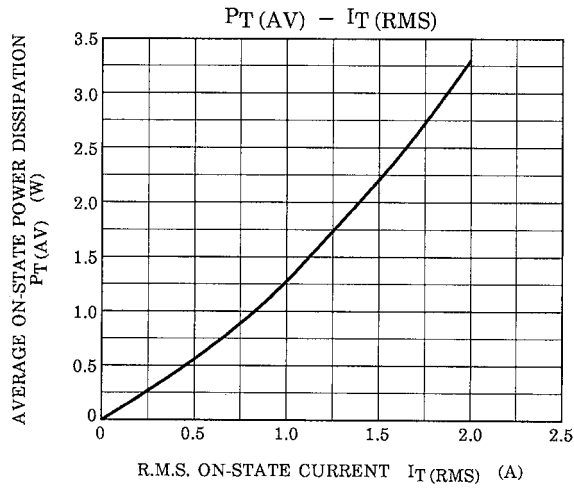

RESTRICTIONS ON PRODUCT USE

000707EAA

- TOSHIBA is continually working to improve the quality and reliability of its products. Nevertheless, semiconductor devices in general can malfunction or fail due to their inherent electrical sensitivity and vulnerability to physical stress. It is the responsibility of the buyer, when utilizing TOSHIBA products, to comply with the standards of safety in making a safe design for the entire system, and to avoid situations in which a malfunction or failure of such TOSHIBA products could cause loss of human life, bodily injury or damage to property.
In developing your designs, please ensure that TOSHIBA products are used within specified operating ranges as set forth in the most recent TOSHIBA products specifications. Also, please keep in mind the precautions and conditions set forth in the "Handling Guide for Semiconductor Devices," or "TOSHIBA Semiconductor Reliability Handbook" etc..
- The TOSHIBA products listed in this document are intended for usage in general electronics applications (computer, personal equipment, office equipment, measuring equipment, industrial robotics, domestic appliances, etc.). These TOSHIBA products are neither intended nor warranted for usage in equipment that requires extraordinarily high quality and/or reliability or a malfunction or failure of which may cause loss of human life or bodily injury ("Unintended Usage"). Unintended Usage include atomic energy control instruments, airplane or spaceship instruments, transportation instruments, traffic signal instruments, combustion control instruments, medical instruments, all types of safety devices, etc.. Unintended Usage of TOSHIBA products listed in this document shall be made at the customer's own risk.
- The information contained herein is presented only as a guide for the applications of our products. No responsibility is assumed by TOSHIBA CORPORATION for any infringements of intellectual property or other rights of the third parties which may result from its use. No license is granted by implication or otherwise under any intellectual property or other rights of TOSHIBA CORPORATION or others.
- The information contained herein is subject to change without notice.

This datasheet has been download from:

www.datasheetcatalog.com

Datasheets for electronics components.