

TL1451A

DUAL PULSE-WIDTH-MODULATION CONTROL CIRCUITS

SLVS024E – FEBRUARY 1983 – REVISED NOVEMBER 1999

- Complete PWM Power Control Circuitry
- Completely Synchronized Operation
- Internal Undervoltage Lockout Protection
- Wide Supply Voltage Range
- Internal Short-Circuit Protection
- Oscillator Frequency . . . 500 kHz Max
- Variable Dead Time Provides Control Over Total Range
- Internal Regulator Provides a Stable 2.5-V Reference Supply
- Available in Q-Temp Automotive HighRel Automotive Applications Configuration Control / Print Support Qualification to Automotive Standards

description

The TL1451A incorporates on a single monolithic chip all the functions required in the construction of two pulse-width-modulation (PWM) control circuits. Designed primarily for power-supply control, the TL1451A contains an on-chip 2.5-V regulator, two error amplifiers, an adjustable oscillator, two dead-time comparators, undervoltage lockout circuitry, and dual common-emitter output transistor circuits.

The uncommitted output transistors provide common-emitter output capability for each

controller. The internal amplifiers exhibit a common-mode voltage range from 1.04 V to 1.45 V. The dead-time control (DTC) comparator has no offset unless externally altered and can provide 0% to 100% dead time. The on-chip oscillator can be operated by terminating RT and CT. During low V_{CC} conditions, the undervoltage lockout control circuit feature locks the outputs off until the internal circuitry is operational.

The TL1451AC is characterized for operation from -20°C to 85°C . The TL1451AQ is characterized for operation from -40°C to 125°C . The TL1451AM is characterized for operation from -55°C to 125°C .

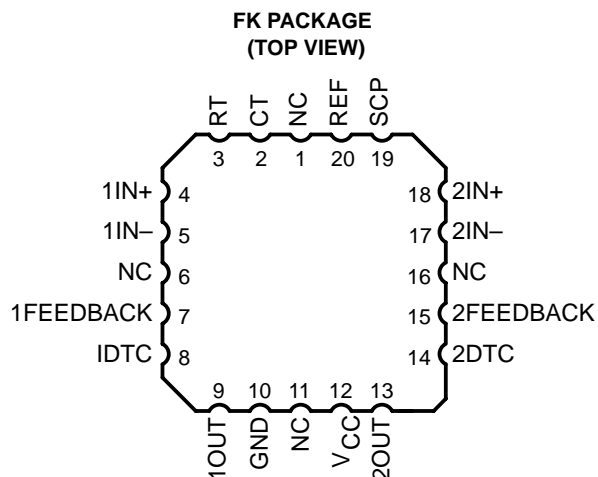
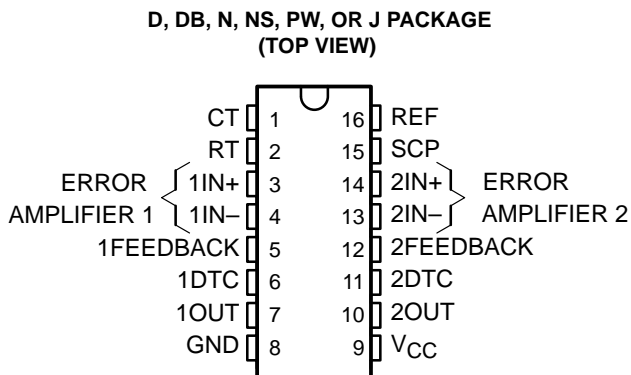

AVAILABLE OPTIONS

T _A	PACKAGED DEVICES						
	SMALL OUTLINE (D)	SMALL OUTLINE (DB) [†]	PLASTIC DIP (N)	SMALL OUTLINE (NS)	TSSOP (PW) [†]	CHIP CARRIER (FK)	CERAMIC DIP (J)
-20°C to 85°C	TL1451ACD	TL1451ACDB	TL1451ACN	TL1451ACNS	TL1451ACPW	—	—
-40°C to 125°C	TL1451AQD	—	—	—	—	—	—
-55°C to 125°C	—	—	—	—	—	TL1451AMFK	TL1451AMJ

[†] The DB and PW packages are only available left-end taped and reeled (add LE suffix, i.e., TL1451ACPWLE).



Please be aware that an important notice concerning availability, standard warranty, and use in critical applications of Texas Instruments semiconductor products and disclaimers thereto appears at the end of this data sheet.

PRODUCTION DATA information is current as of publication date. Products conform to specifications per the terms of Texas Instruments standard warranty. Production processing does not necessarily include testing of all parameters.

**TEXAS
INSTRUMENTS**
www.ti.com

Copyright © 1999, Texas Instruments Incorporated
On products compliant to MIL-PRF-38535, all parameters are tested unless otherwise noted. On all other products, production processing does not necessarily include testing of all parameters.

TL1451A DUAL PULSE-WIDTH-MODULATION CONTROL CIRCUITS

SLVS024E – FEBRUARY 1983 – REVISED NOVEMBER 1999

functional block diagram

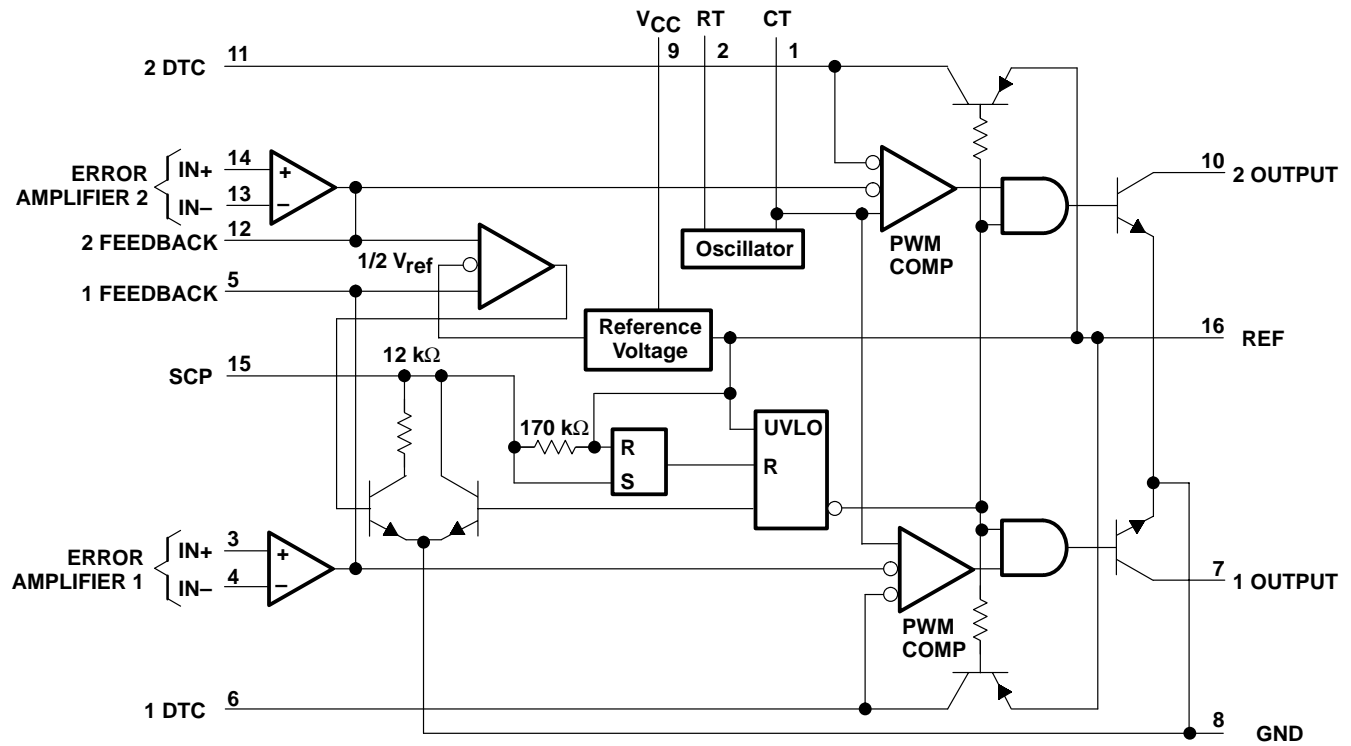

COMPONENT COUNT

Resistors	65
Capacitors	8
Transistors	105
JFETs	18

TL1451A

DUAL PULSE-WIDTH-MODULATION CONTROL CIRCUITS

SLVS024E – FEBRUARY 1983 – REVISED NOVEMBER 1999

absolute maximum ratings over operating free-air temperature range†

Supply voltage, V_{CC}	51 V
Amplifier input voltage, V_I	20 V
Collector output voltage, V_O	51 V
Collector output current, I_O	21 mA
Continuous power total dissipation	See Dissipation Rating Table
Operating free-air temperature range, T_A C suffix	–20°C to 85°C
Q suffix	–40°C to 125°C
M suffix	–55°C to 125°C
Storage temperature range, T_{stg}	–65°C to 150°C
Lead temperature 1,6 mm (1/16 inch) from case for 10 seconds	260°C

† Stresses beyond those listed under “absolute maximum ratings” may cause permanent damage to the device. These are stress ratings only, and functional operation of the device at these or any other conditions beyond those indicated under “recommended operating conditions” is not implied. Exposure to absolute-maximum-rated conditions for extended periods may affect device reliability.

DISSIPATION RATING TABLE

PACKAGE	$T_A \leq 25^\circ\text{C}$ POWER RATING	DERATING FACTOR ABOVE $T_A = 25^\circ\text{C}$	$T_A = 70^\circ\text{C}$ POWER RATING	$T_A = 85^\circ\text{C}$ POWER RATING	$T_A = 125^\circ\text{C}$ POWER RATING
D	1088 mW	8.7 mW/°C	696 mW	566 mW	218 mW
DB	775 mW	6.2 mW/°C	496 mW	403 mW	—
N	1000 mW	8.0 mW/°C	640 mW	520 mW	—
NS	500 mW	4.0 mW/°C	320 mW	260 mW	—
PW	838 mW	6.7 mW/°C	536 mW	436 mW	168 mW
FK	1375 mW	11.0 mW/°C	880 mW	715 mW	275 mW
J	1375 mW	11.0 mW/°C	880 mW	715 mW	275 mW

recommended operating conditions

	MIN	MAX	UNIT
Supply voltage, V_{CC}	3.6	50	V
Amplifier input voltage, V_I	1.05	1.45	V
Collector output voltage, V_O		50	V
Collector output current, I_O		20	mA
Current into feedback terminal		45	μA
Feedback resistor, R_F	100		kΩ
Timing capacitor, C_T	150	15000	pF
Timing resistor, R_T	5.1	100	kΩ
Oscillator frequency	1	500	kHz
Operating free-air temperature, T_A	C suffix	–20	85
	Q suffix	–40	125
	M suffix	–55	125
			°C

TL1451A

DUAL PULSE-WIDTH-MODULATION CONTROL CIRCUITS

SLVS024E – FEBRUARY 1983 – REVISED NOVEMBER 1999

electrical characteristics over recommended operating free-air temperature range, $V_{CC} = 6\text{ V}$, $f = 200\text{ kHz}$ (unless otherwise noted)

reference section

PARAMETER	TEST CONDITIONS	TL1451AC			UNIT
		MIN	TYP†	MAX	
Output voltage (pin 16)	$I_O = 1\text{ mA}$	2.4	2.5	2.6	V
Output voltage change with temperature	$T_A = -20^\circ\text{C}$ to 25°C		-0.1%	$\pm 1\%$	
	$T_A = 25^\circ\text{C}$ to 85°C		-0.2%	$\pm 1\%$	
Input voltage regulation	$V_{CC} = 3.6\text{ V}$ to 40 V		2	12.5	mV
Output voltage regulation	$I_O = 0.1\text{ mA}$ to 1 mA		1	7.5	mV
Short-circuit output current	$V_O = 0$	3	10	30	mA

† All typical values are at $T_A = 25^\circ\text{C}$.

undervoltage lockout section

PARAMETER	TEST CONDITIONS	TL1451AC			UNIT
		MIN	TYP†	MAX	
Upper threshold voltage (V_{CC})	$I_{O(\text{ref})} = 0.1\text{ mA}$, $T_A = 25^\circ\text{C}$		2.72		V
Lower threshold voltage (V_{CC})			2.6		V
Hysteresis (V_{CC})		80	120		mV
Reset threshold voltage (V_{CC})		1.5	1.9		V

† All typical values are at $T_A = 25^\circ\text{C}$.

short-circuit protection control section

PARAMETER	TEST CONDITIONS	TL1451AC			UNIT
		MIN	TYP†	MAX	
Input threshold voltage (SCP)	$T_A = 25^\circ\text{C}$	0.65	0.7	0.75	V
Standby voltage (SCP)	No pullup	140	185	230	mV
Latched input voltage (SCP)	No pullup		60	120	mV
Input (source) current	$V_I = 0.7\text{ V}$, $T_A = 25^\circ\text{C}$	-10	-15	-20	μA
Comparator threshold voltage (FEEDBACK)			1.18		V

† All typical values are at $T_A = 25^\circ\text{C}$.

oscillator section

PARAMETER	TEST CONDITIONS	TL1451C			UNIT
		MIN	TYP†	MAX	
Frequency	$C_T = 330\text{ pF}$, $R_T = 10\text{ k}\Omega$		200		kHz
Standard deviation of frequency	$C_T = 330\text{ pF}$, $R_T = 10\text{ k}\Omega$		10%		
Frequency change with voltage	$V_{CC} = 3.6\text{ V}$ to 40 V		1%		
Frequency change with temperature	$T_A = -20^\circ\text{C}$ to 25°C		-0.4%	$\pm 2\%$	
	$T_A = 25^\circ\text{C}$ to 85°C		-0.2%	$\pm 2\%$	

† All typical values are at $T_A = 25^\circ\text{C}$.

TL1451A

DUAL PULSE-WIDTH-MODULATION CONTROL CIRCUITS

SLVS024E – FEBRUARY 1983 – REVISED NOVEMBER 1999

dead-time control section

PARAMETER	TEST CONDITIONS	TL1451AC			UNIT
		MIN	TYP†	MAX	
Input bias current (DTC)				1	μA
Latch mode (source) current (DTC)	T _A = 25°C	-80	-145		μA
Latched input voltage (DTC)	I _O = 40 μA	2.3			V
Input threshold voltage at f = 10 kHz (DTC)	Zero duty cycle		2.05	2.25	V
	Maximum duty cycle	1.2	1.45		

† All typical values are at T_A = 25°C.

error-amplifier section

PARAMETER	TEST CONDITIONS	TL1451AC			UNIT
		MIN	TYP†	MAX	
Input offset voltage	V _O (FEEDBACK) = 1.25 V			±6	mV
Input offset current	V _O (FEEDBACK) = 1.25 V			±100	nA
Input bias current	V _O (FEEDBACK) = 1.25 V		160	500	nA
Common-mode input voltage range	V _{CC} = 3.6 V to 40 V	1.05 to 1.45			V
Open-loop voltage amplification	R _F = 200 kΩ	70	80		dB
Unity-gain bandwidth			1.5		MHz
Common-mode rejection ratio		60	80		dB
Positive output voltage swing				V _{ref} -0.1	V
Negative output voltage swing				1	V
Output (sink) current (FEEDBACK)	V _{ID} = -0.1 V, V _O = 1.25 V	0.5	1.6		mA
Output (source) current (FEEDBACK)	V _{ID} = 0.1 V, V _O = 1.25 V	-45	-70		μA

† All typical values are at T_A = 25°C.

output section

PARAMETER	TEST CONDITIONS	TL1451AC			UNIT
		MIN	TYP†	MAX	
Collector off-state current	V _O = 50 V			10	μA
Output saturation voltage	I _O = 10 mA		1.2	2	V
Short-circuit output current	V _O = 6 V		90		mA

† All typical values are at T_A = 25°C.

pwm comparator section

PARAMETER	TEST CONDITIONS	TL1451AC			UNIT
		MIN	TYP†	MAX	
Input threshold voltage at f = 10 kHz (FEEDBACK)	Zero duty cycle		2.05	2.25	V
	Maximum duty cycle	1.2	1.45		

† All typical values are at T_A = 25°C.

total device

PARAMETER	TEST CONDITIONS	TL1451AC			UNIT
		MIN	TYP†	MAX	
Standby supply current	Off-state		1.3	1.8	mA
Average supply current	R _T = 10 kΩ		1.7	2.4	mA

† All typical values are at T_A = 25°C.

TL1451A

DUAL PULSE-WIDTH-MODULATION CONTROL CIRCUITS

SLVS024E – FEBRUARY 1983 – REVISED NOVEMBER 1999

electrical characteristics over recommended operating free-air temperature range, $V_{CC} = 6\text{ V}$, $f = 200\text{ kHz}$ (unless otherwise noted)

reference section

PARAMETER	TEST CONDITIONS		TL1451AQ, TL1451AM			UNIT
			MIN	TYP†	MAX	
Output voltage (pin 16)	$I_O = 1\text{ mA}$	$T_A = 25^\circ\text{C}$	2.40	2.50	2.60	V
		$T_A = \text{MIN and } 125^\circ\text{C}$	2.35	2.46	2.65	
Output voltage change with temperature			-0.63%		*±4%	
Input voltage regulation	$V_{CC} = 3.6\text{ V to } 40\text{ V}$	$T_A = 25^\circ\text{C}$		2.0	12.5	mV
		$T_A = 125^\circ\text{C}$		0.7	15	
		$T_A = \text{MIN}$		0.3	30	
Output voltage regulation	$I_O = 0.1\text{ mA to } 1\text{ mA}$	$T_A = 25^\circ\text{C}$		1.0	7.5	mV
		$T_A = 125^\circ\text{C}$		0.3	14	
		$T_A = \text{MIN}$		0.3	20	
Short-circuit output current	$V_O = 0$		3	10	30	mA

*These parameters are not production tested.

† All typical values are at $T_A = 25^\circ\text{C}$ unless otherwise indicated.

undervoltage lockout section

PARAMETER	TEST CONDITIONS		TL1451AQ, TL1451AM			UNIT
			MIN	TYP†	MAX	
Upper threshold voltage (V_{CC})		$T_A = 25^\circ\text{C}$		2.72		V
		$T_A = 125^\circ\text{C}$		1.70		
		$T_A = \text{MIN}$		3.15		
Lower threshold voltage (V_{CC})		$T_A = 25^\circ\text{C}$		2.60		V
		$T_A = 125^\circ\text{C}$		1.65		
		$T_A = \text{MIN}$		3.09		
Hysteresis (V_{CC})		$T_A = 25^\circ\text{C}$	80	120		mV
		$T_A = 125^\circ\text{C}$	10	50		
		$T_A = \text{MIN}$	10	60		
Reset threshold voltage (V_{CC})		$T_A = 25^\circ\text{C}$		1.50		V
		$T_A = 125^\circ\text{C}$		0.95		
		$T_A = \text{MIN}$		1.50		

† All typical values are at $T_A = 25^\circ\text{C}$ unless otherwise indicated.

TL1451A

DUAL PULSE-WIDTH-MODULATION CONTROL CIRCUITS

SLVS024E – FEBRUARY 1983 – REVISED NOVEMBER 1999

short-circuit protection control section

PARAMETER	TEST CONDITIONS	TL1451AQ, TL1451AM			UNIT
		MIN	TYP†	MAX	
Input threshold voltage (SCP)	$T_A = 25^\circ\text{C}$	650	700	750	mV
	$T_A = 125^\circ\text{C}$	400	478	550	
	$T_A = \text{MIN}$	800	880	950	
Standby voltage (SCP)		140	185	230	mV
Latched input voltage (SCP)	$T_A = 25^\circ\text{C}$		60	120	mV
	$T_A = 125^\circ\text{C}$		70	120	
	$T_A = \text{MIN}$		60	120	
Equivalent timing resistance			170		k Ω
Comparator threshold voltage (FEEDBACK)			1.18		V

† All typical values are at $T_A = 25^\circ\text{C}$ unless otherwise indicated.

oscillator section

PARAMETER	TEST CONDITIONS	TL1451AQ, TL1451AM			UNIT
		MIN	TYP†	MAX	
Frequency	$C_T = 330\text{ pF}$, $R_T = 10\text{ k}\Omega$	$T_A = 25^\circ\text{C}$	200		kHz
		$T_A = 125^\circ\text{C}$	195		
		$T_A = \text{MIN}$	193		
Standard deviation of frequency	$C_T = 330\text{ pF}$, $R_T = 10\text{ k}\Omega$		2%		
Frequency change with voltage	$V_{CC} = 3.6\text{ V to }40\text{ V}$	$T_A = 25^\circ\text{C}$	1%		
		$T_A = 125^\circ\text{C}$	1%		
		$T_A = \text{MIN}$	3%		
Frequency change with temperature			1.37%	$\pm 10\%$	

*These parameters are not production tested.

† All typical values are at $T_A = 25^\circ\text{C}$ unless otherwise indicated.

dead-time control section

PARAMETER	TEST CONDITIONS	TL1451AQ, TL1451AM			UNIT
		MIN	TYP†	MAX	
Input bias current (DTC)	$T_A = 25^\circ\text{C}$			1	μA
	$T_A = \text{MIN and } 125^\circ\text{C}$			3	
Latch mode (source) current (DTC)		-80	-145		μA
Latched input voltage (DTC)	$T_A = 25^\circ\text{C}$	2.30		V	
	$T_A = 125^\circ\text{C}$	2.22	2.32		
	$T_A = \text{MIN}$	2.28	2.40		
Input threshold voltage at $f = 10\text{ kHz}$ (DTC)	Zero duty cycle		2.05	*2.25	V
	Maximum duty cycle	*1.20	1.45		

*These parameters are not production tested.

† All typical values are at $T_A = 25^\circ\text{C}$ unless otherwise indicated.

TL1451A

DUAL PULSE-WIDTH-MODULATION CONTROL CIRCUITS

SLVS024E – FEBRUARY 1983 – REVISED NOVEMBER 1999

error-amplifier section

PARAMETER	TEST CONDITIONS	TL1451AQ, TL1451AM			UNIT
		MIN	TYP†	MAX	
Input offset voltage	V_O (FEEDBACK) = 1.25 V	$T_A = 25^\circ\text{C}$	±6		mV
		$T_A = 125^\circ\text{C}$	±10		
		$T_A = \text{MIN}$	±12		
Input offset current	V_O (FEEDBACK) = 1.25 V	$T_A = 25^\circ\text{C}$	±100		nA
		$T_A = 125^\circ\text{C}$	±100		
		$T_A = \text{MIN}$	±200		
Input bias current	V_O (FEEDBACK) = 1.25 V	$T_A = 25^\circ\text{C}$	160	500	nA
		$T_A = 125^\circ\text{C}$	100	500	
		$T_A = \text{MIN}$	142	700	
Common-mode input voltage range	$V_{CC} = 3.6 \text{ V to } 40 \text{ V}$	1.05 to 1.45			V
Open-loop voltage amplification	$R_F = 200 \text{ k}\Omega$	$T_A = 25^\circ\text{C}$	70	80	dB
		$T_A = 125^\circ\text{C}$	70	80	
		$T_A = \text{MIN}$	64	80	
Unity-gain bandwidth		1.5		MHz	
Common-mode rejection ratio		60	80	dB	
Positive output voltage swing		2		V	
Negative output voltage swing		1		V	
Output (sink) current (FEEDBACK)	$V_{ID} = -0.1 \text{ V}, V_O = 1.25 \text{ V}$	$T_A = 25^\circ\text{C}$	0.5	1.6	mA
		$T_A = 125^\circ\text{C}$	0.4	1.8	
		$T_A = \text{MIN}$	0.3	1.7	
Output (source) current (FEEDBACK)	$V_{ID} = 0.1 \text{ V}, V_O = 1.25 \text{ V}$	$T_A = 25^\circ\text{C}$	-45	-70	μA
		$T_A = 125^\circ\text{C}$	-25	-50	
		$T_A = \text{MIN}$	-15	-70	

† All typical values are at $T_A = 25^\circ\text{C}$ unless otherwise indicated.

output section

PARAMETER	TEST CONDITIONS	TL1451AQ, TL1451AM			UNIT
		MIN	TYP†	MAX	
Collector off-state current	$V_O = 50 \text{ V}$			10	μA
Output saturation voltage	$T_A = 25^\circ\text{C}$			1.20	V
	$T_A = 125^\circ\text{C}$			1.60	
	$T_A = \text{MIN}$			1.36	
Short-circuit output current	$V_O = 6 \text{ V}$			90	mA

† All typical values are at $T_A = 25^\circ\text{C}$ unless otherwise indicated.

pwm comparator section

PARAMETER	TEST CONDITIONS	TL1451AQ, TL1451AM			UNIT
		MIN	TYP†	MAX	
Input threshold voltage at $f = 10 \text{ kHz}$ (FEEDBACK)	Zero duty cycle			2.05	V
	Maximum duty cycle	*1.20	1.45	*2.25	

*These parameters are not production tested.

† All typical values are at $T_A = 25^\circ\text{C}$ unless otherwise indicated.

TL1451A

DUAL PULSE-WIDTH-MODULATION CONTROL CIRCUITS

SLVS024E – FEBRUARY 1983 – REVISED NOVEMBER 1999

total device

PARAMETER	TEST CONDITIONS	TL1451AQ, TL1451AM			UNIT
		MIN	TYP†	MAX	
Standby supply current	Off-state		1.3	1.8	mA
Average supply current	$R_T = 10\text{ k}\Omega$		1.7	2.4	mA

† All typical values are at $T_A = 25^\circ\text{C}$ unless otherwise indicated.

PARAMETER MEASUREMENT INFORMATION

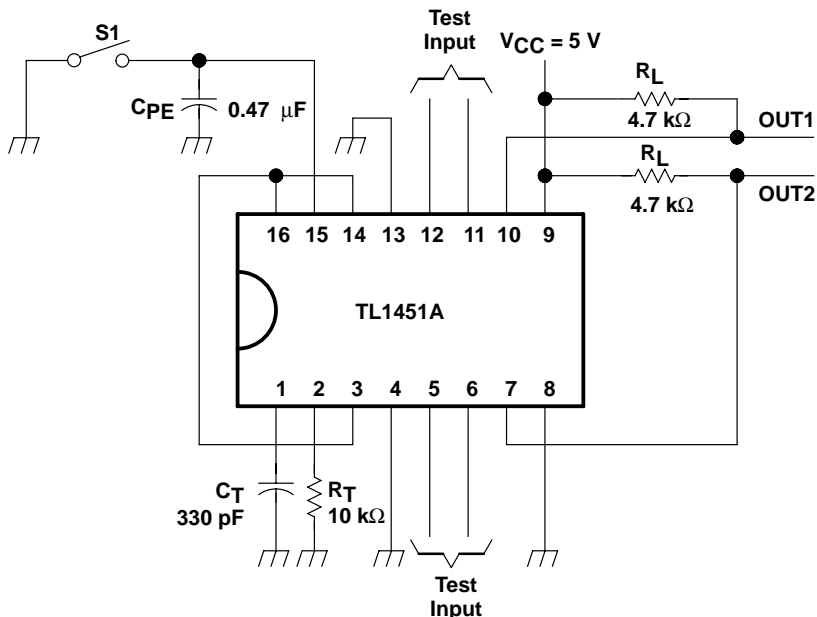
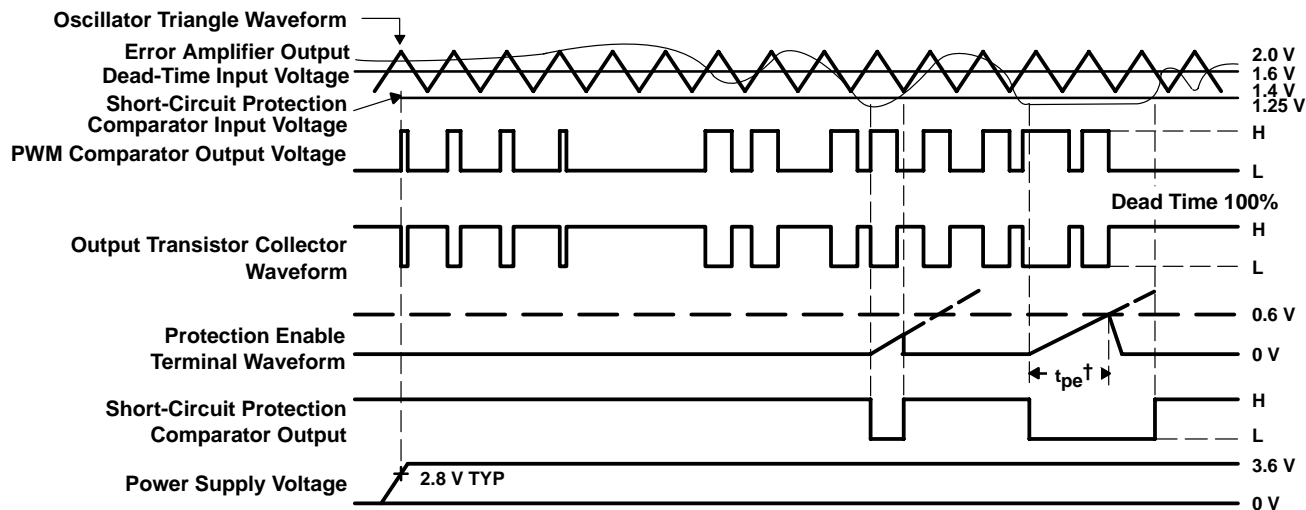

Figure 1. Test Circuit



† Protection Enable Time, $t_{pe} = (0.051 \times 10^6 \times C_{pe})$ in seconds

Figure 2. TL1451A Timing Diagram

TL1451A DUAL PULSE-WIDTH-MODULATION CONTROL CIRCUITS

SLVS024E – FEBRUARY 1983 – REVISED NOVEMBER 1999

TYPICAL CHARACTERISTICS

TRIANGLE OSCILLATOR FREQUENCY
vs
TIMING RESISTANCE

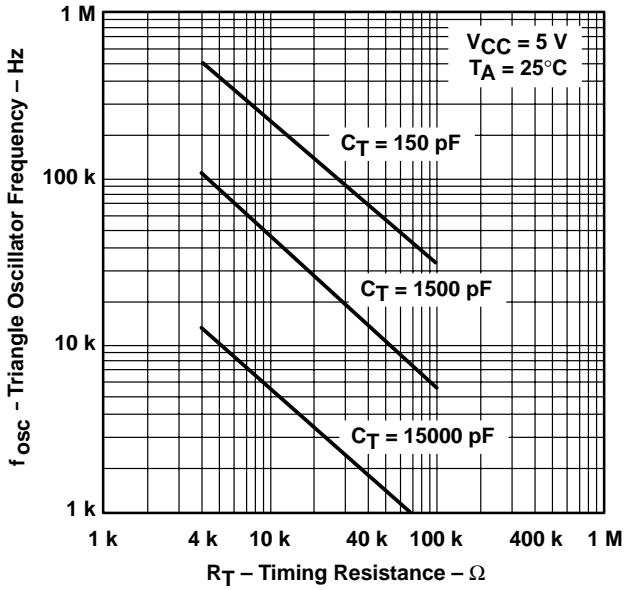

Figure 3

OSCILLATOR FREQUENCY VARIATION
vs
FREE-AIR TEMPERATURE

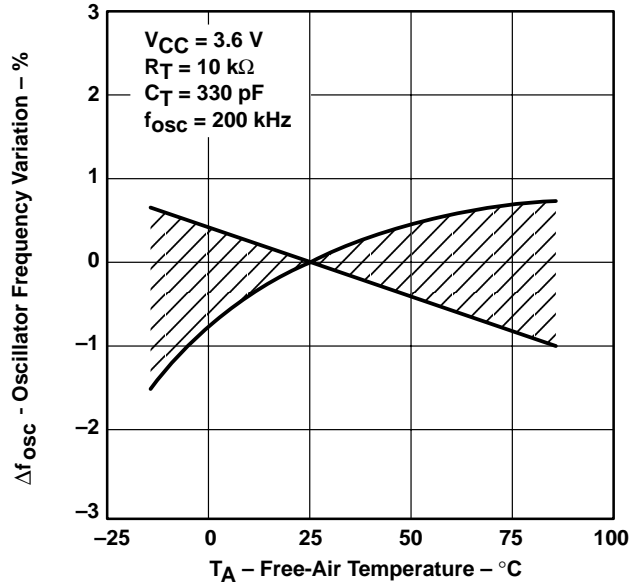

Figure 4

TRIANGLE WAVEFORM SWING VOLTAGE
vs
TIMING CAPACITANCE

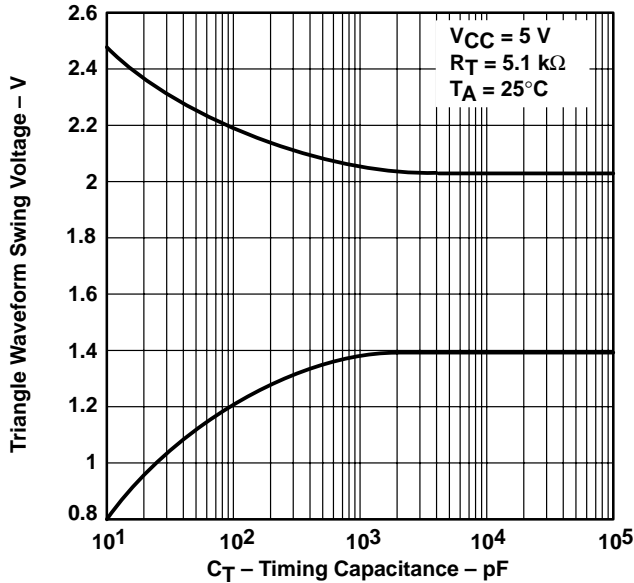

Figure 5

TRIANGLE WAVEFORM PERIOD
vs
TIMING CAPACITANCE

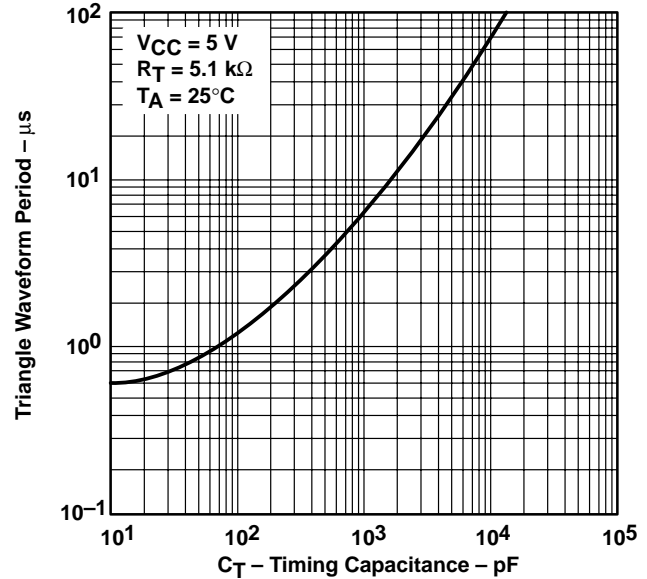

Figure 6

TYPICAL CHARACTERISTICS

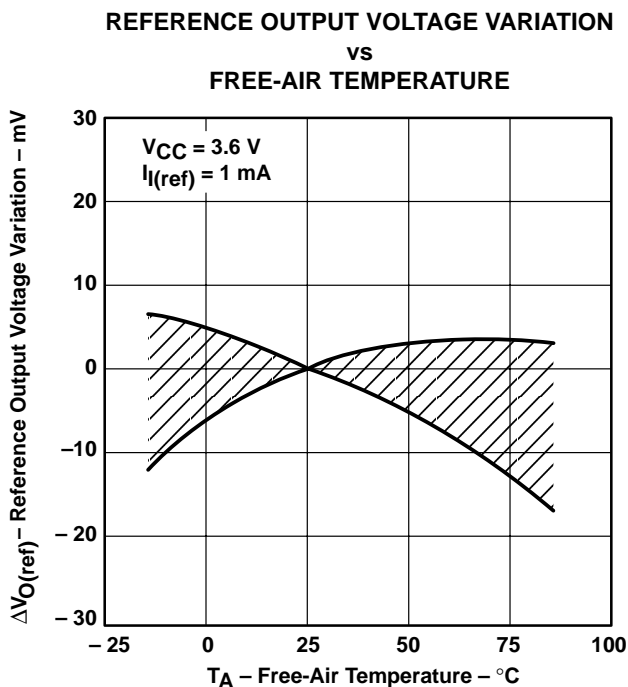

Figure 7

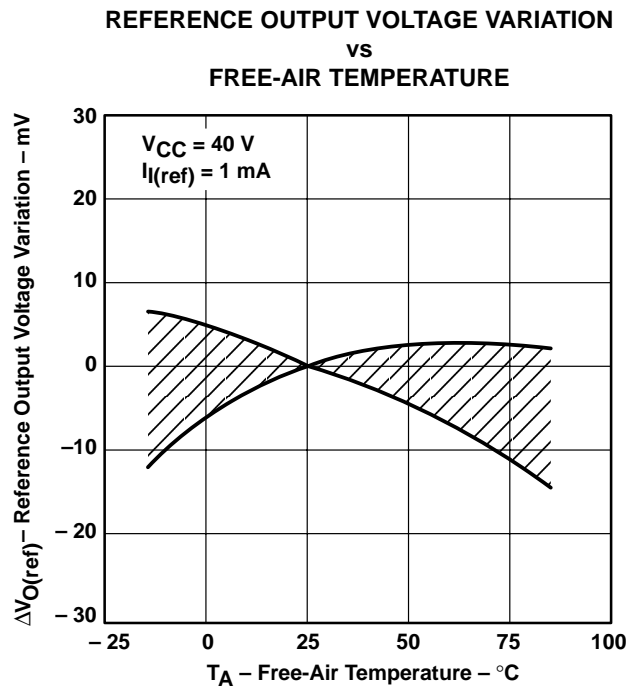

Figure 8

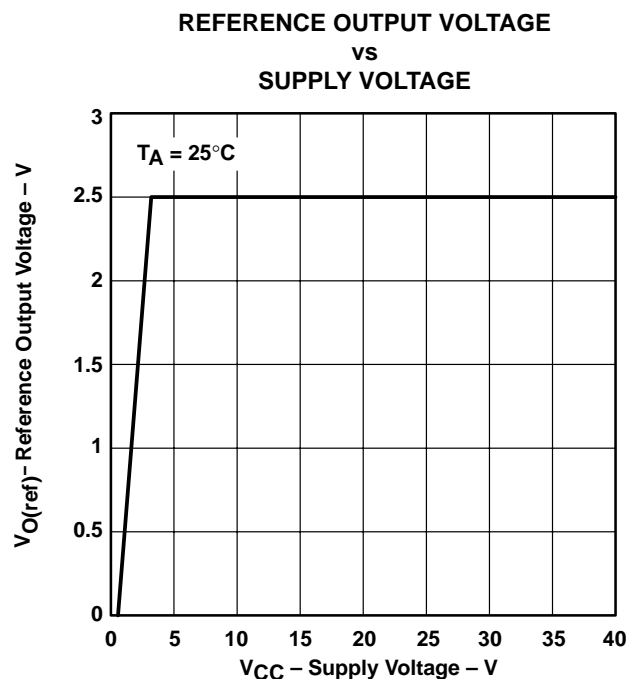

Figure 9

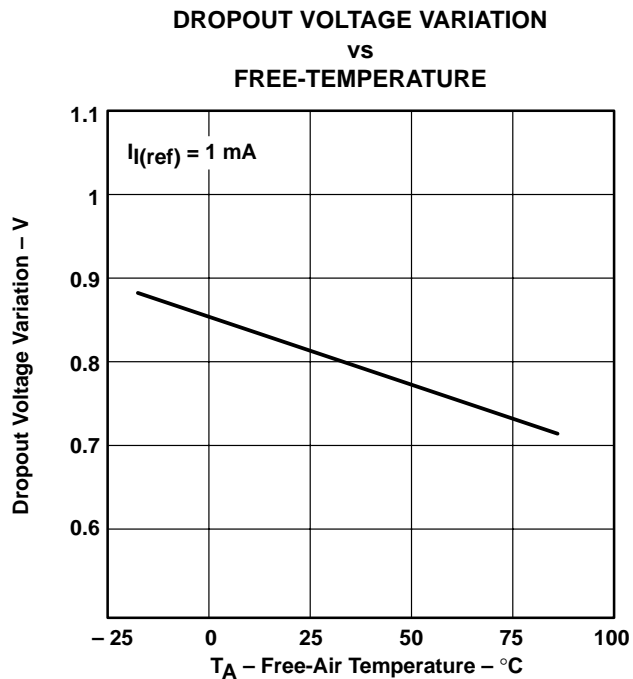

Figure 10

TL1451A DUAL PULSE-WIDTH-MODULATION CONTROL CIRCUITS

SLVS024E – FEBRUARY 1983 – REVISED NOVEMBER 1999

TYPICAL CHARACTERISTICS

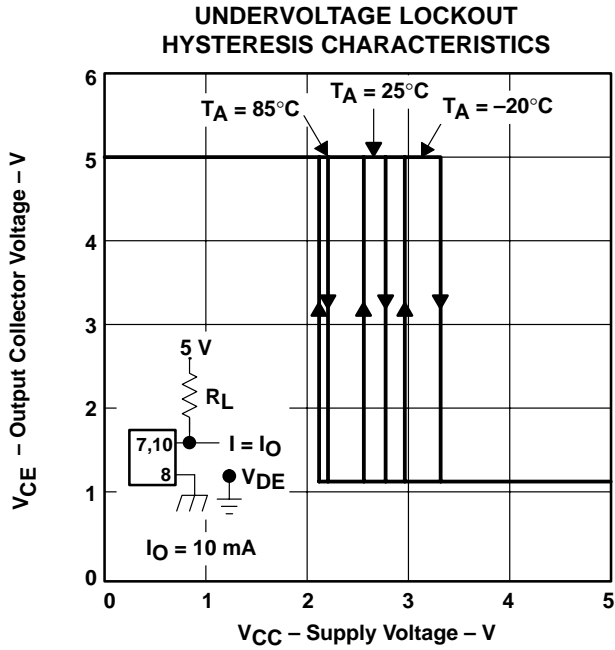

Figure 11

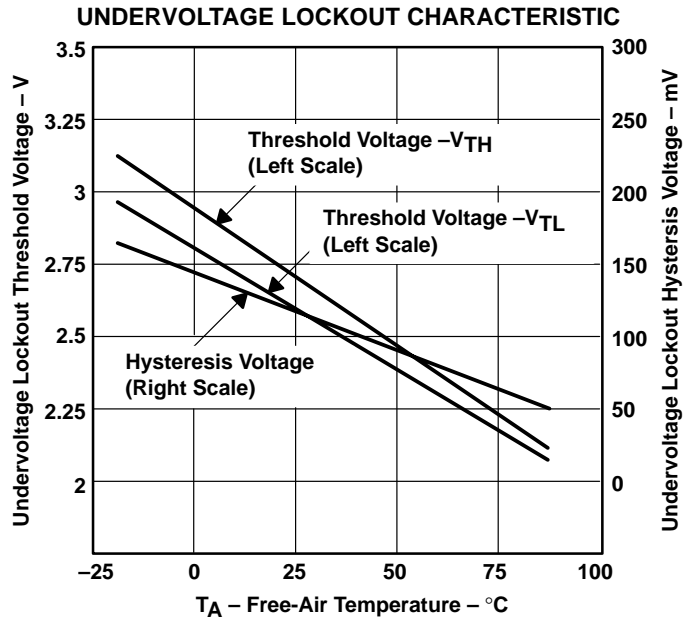

Figure 12

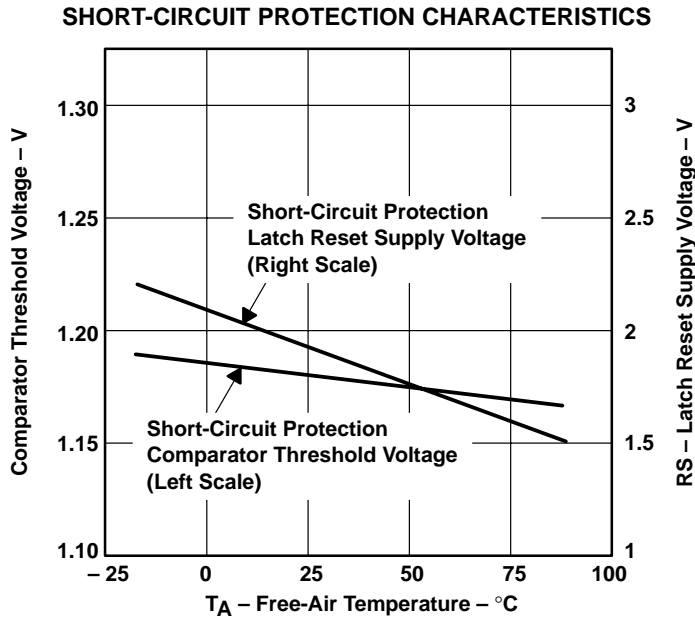

Figure 13

TYPICAL CHARACTERISTICS

**PROTECTION ENABLE TIME
vs
PROTECTION ENABLE CAPACITANCE**

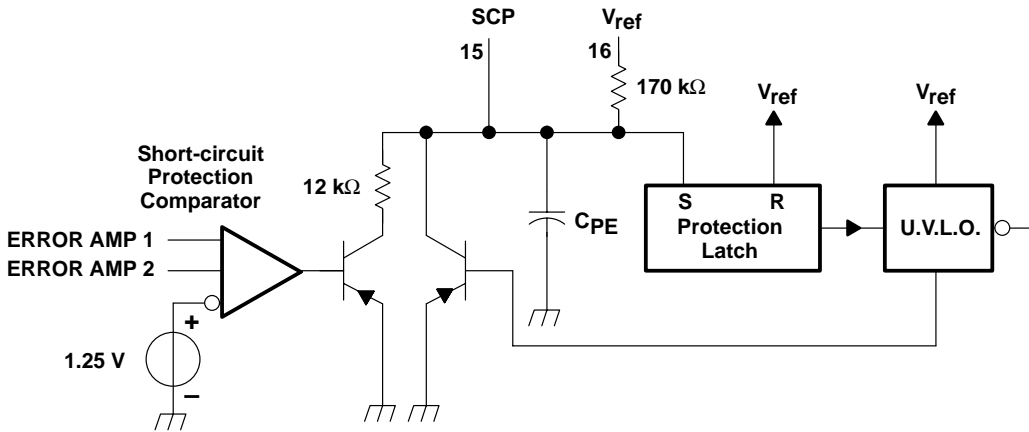
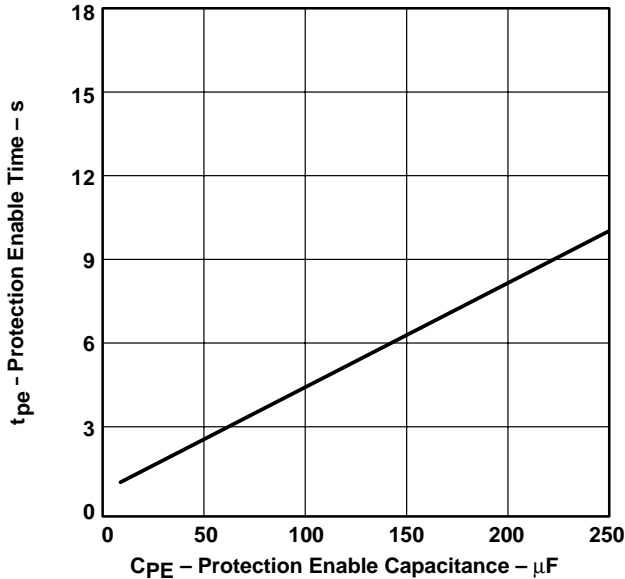

Figure 14

TL1451A DUAL PULSE-WIDTH-MODULATION CONTROL CIRCUITS

SLVS024E – FEBRUARY 1983 – REVISED NOVEMBER 1999

TYPICAL CHARACTERISTICS

**ERROR AMP MAXIMUM OUTPUT VOLTAGE SWING
vs
FREQUENCY**

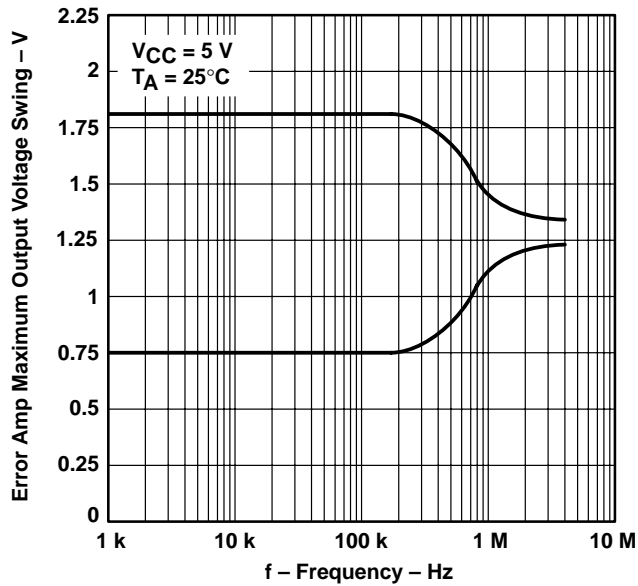

Figure 15

**OPEN-LOOP VOLTAGE AMPLIFICATION
vs
FREQUENCY**

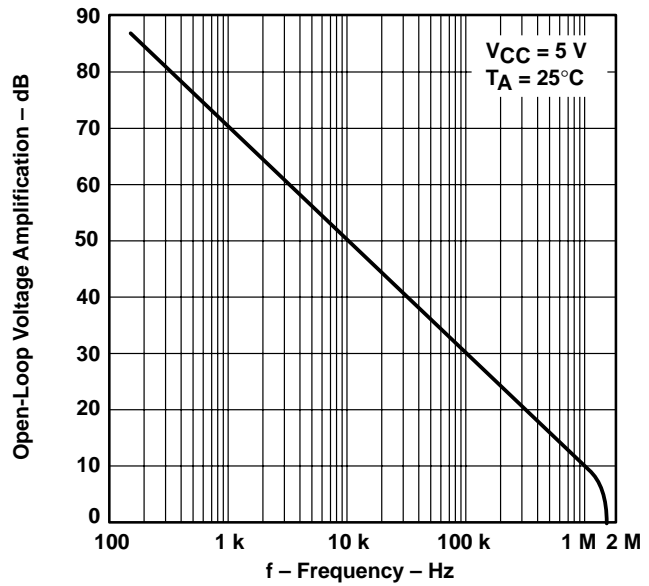

Figure 16

**GAIN (AMPLIFIER IN
UNITY-GAIN CONFIGURATION)
vs
FREQUENCY**

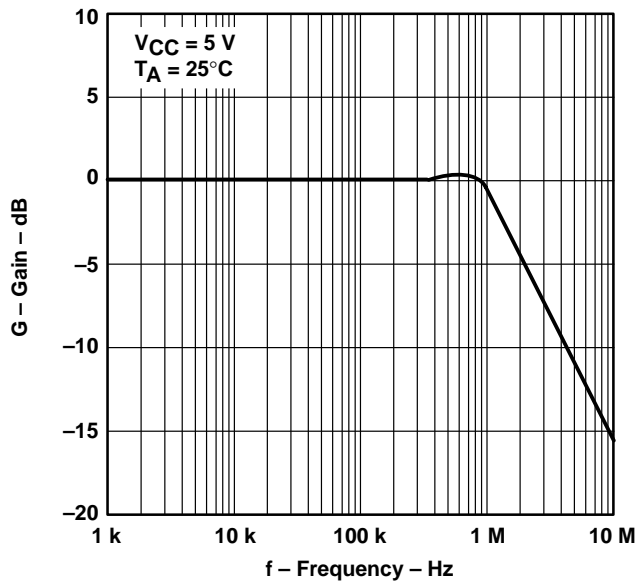
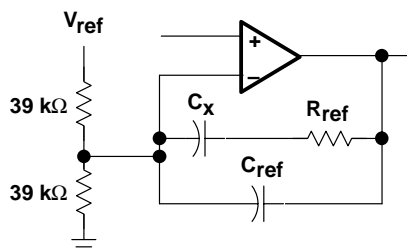
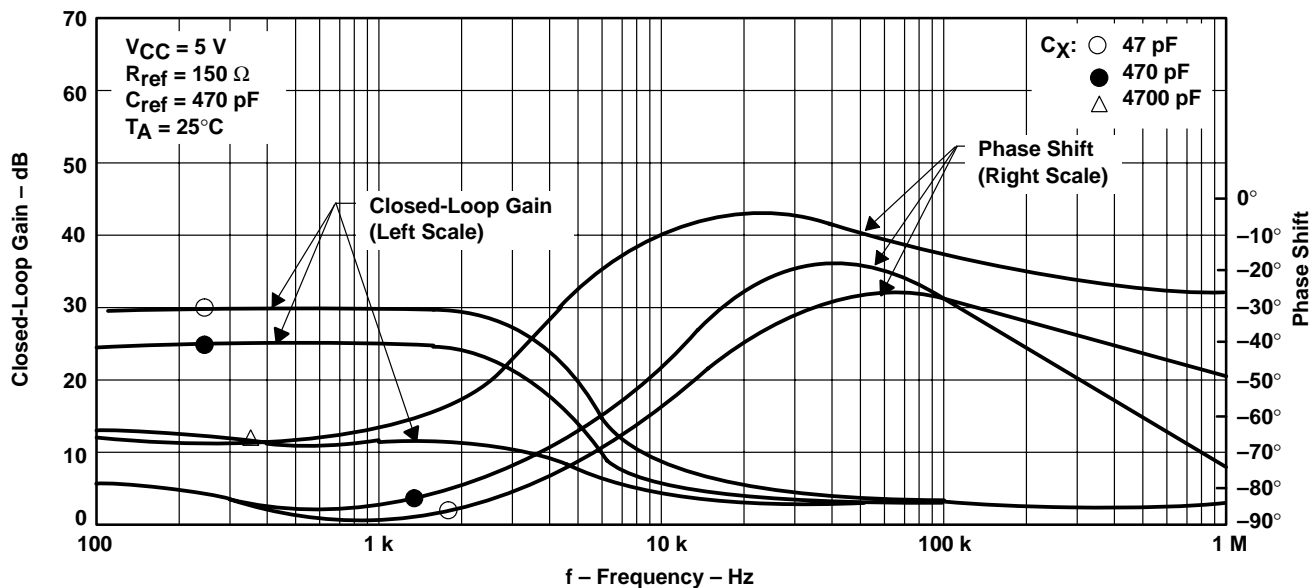

Figure 17

TYPICAL CHARACTERISTICS

CLOSED-LOOP GAIN AND PHASE SHIFT vs FREQUENCY



Test Circuit

Figure 18

TL1451A DUAL PULSE-WIDTH-MODULATION CONTROL CIRCUITS

SLVS024E – FEBRUARY 1983 – REVISED NOVEMBER 1999

TYPICAL CHARACTERISTICS

CLOSED-LOOP GAIN AND PHASE SHIFT vs FREQUENCY

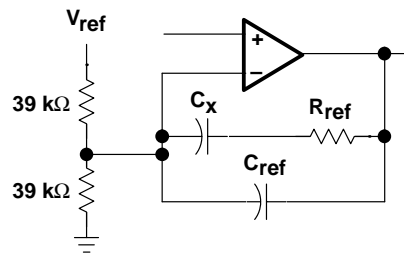
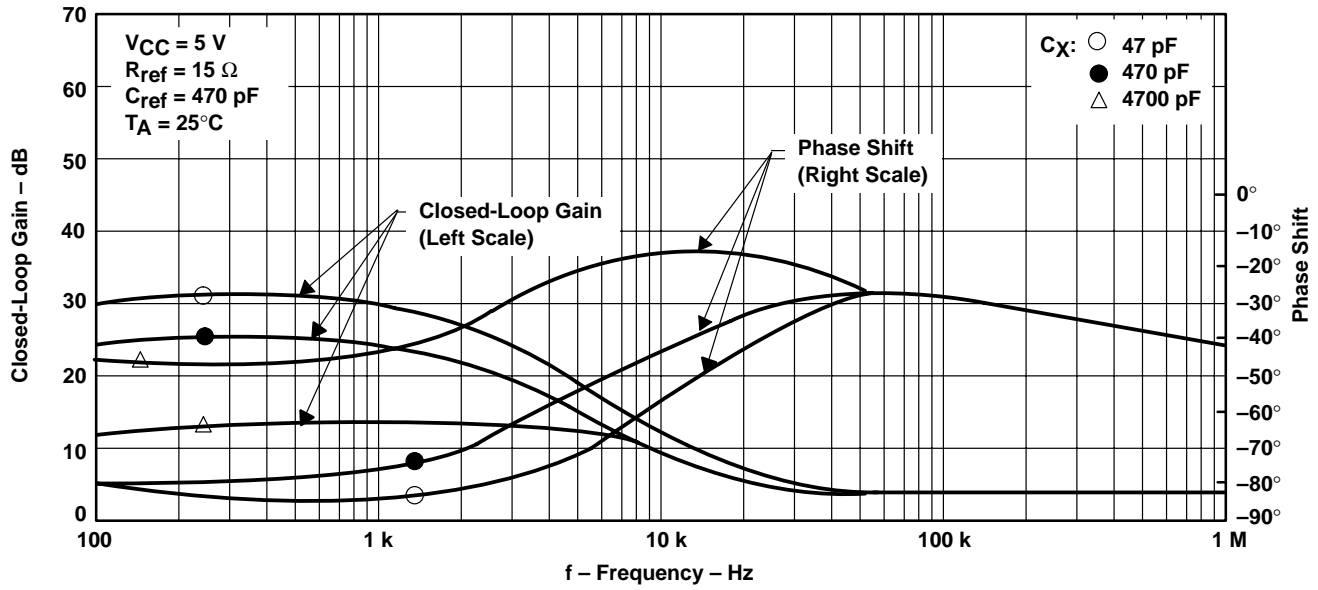

Test Circuit

Figure 19

TYPICAL CHARACTERISTICS

CLOSED-LOOP GAIN AND PHASE SHIFT VS FREQUENCY

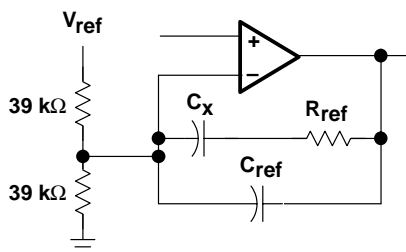
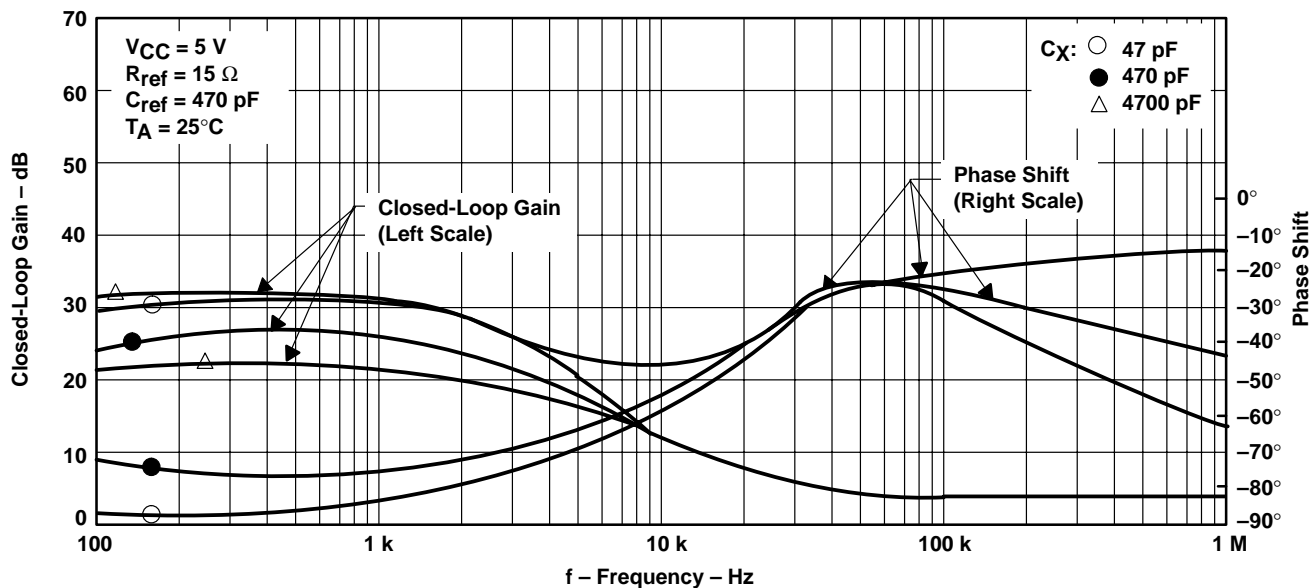

Test Circuit

Figure 20

TL1451A DUAL PULSE-WIDTH-MODULATION CONTROL CIRCUITS

SLVS024E – FEBRUARY 1983 – REVISED NOVEMBER 1999

TYPICAL CHARACTERISTICS CLOSED-LOOP GAIN AND PHASE SHIFT vs FREQUENCY

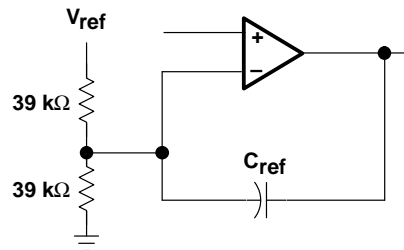
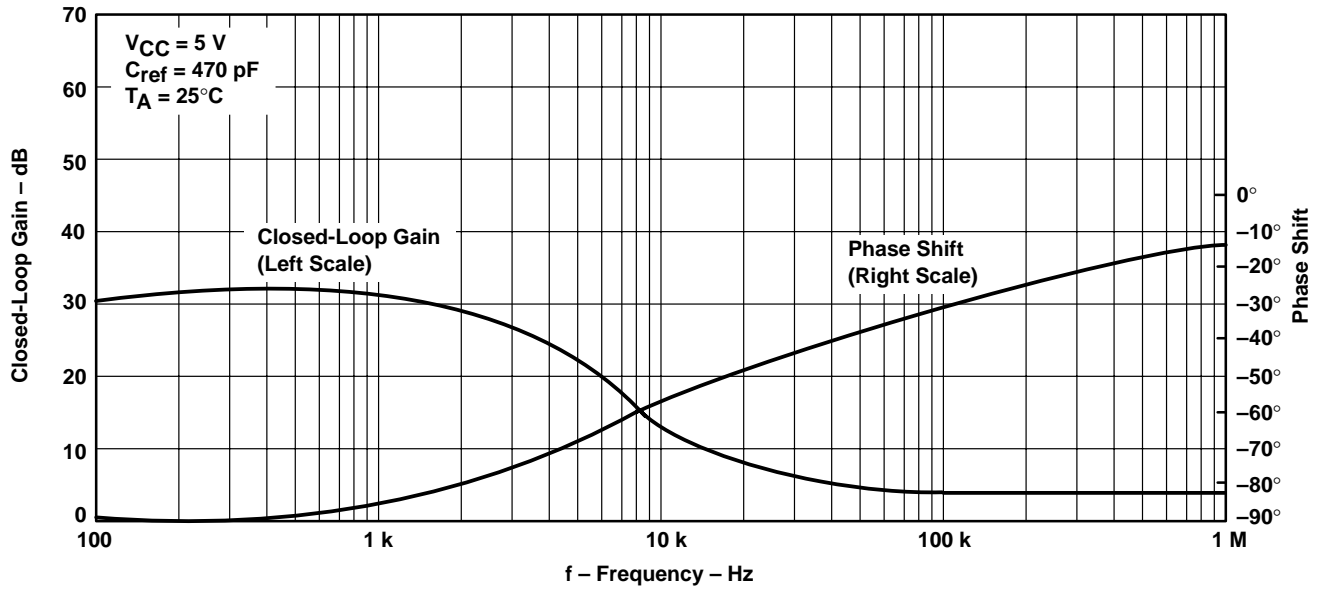

Test Circuit

Figure 21

TYPICAL CHARACTERISTICS

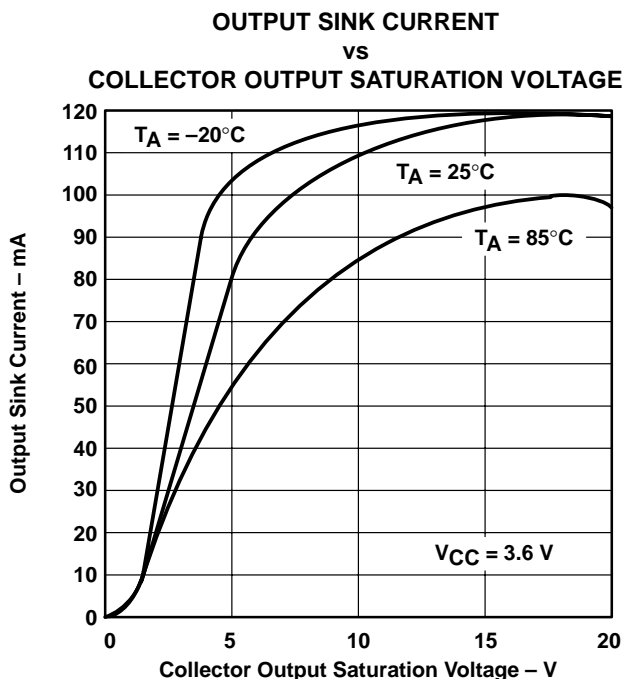

Figure 22

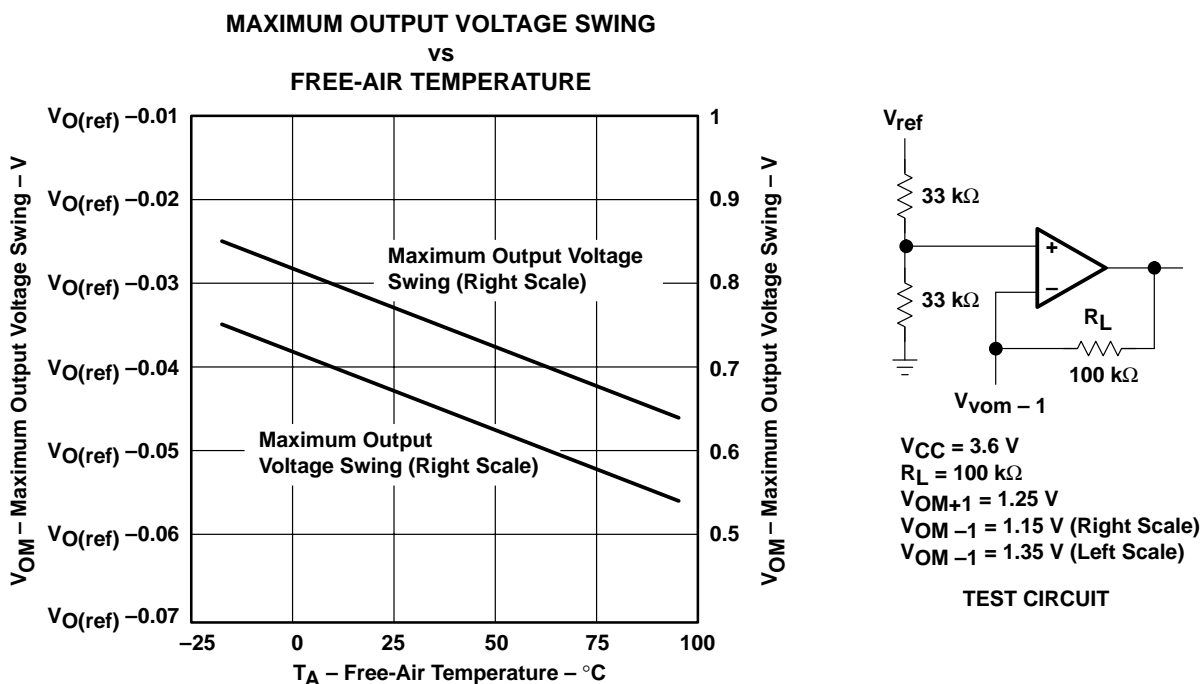

Figure 23

TL1451A DUAL PULSE-WIDTH-MODULATION CONTROL CIRCUITS

SLVS024E – FEBRUARY 1983 – REVISED NOVEMBER 1999

TYPICAL CHARACTERISTICS

OUTPUT TRANSISTOR ON DUTY CYCLE
vs
DEAD-TIME INPUT VOLTAGE

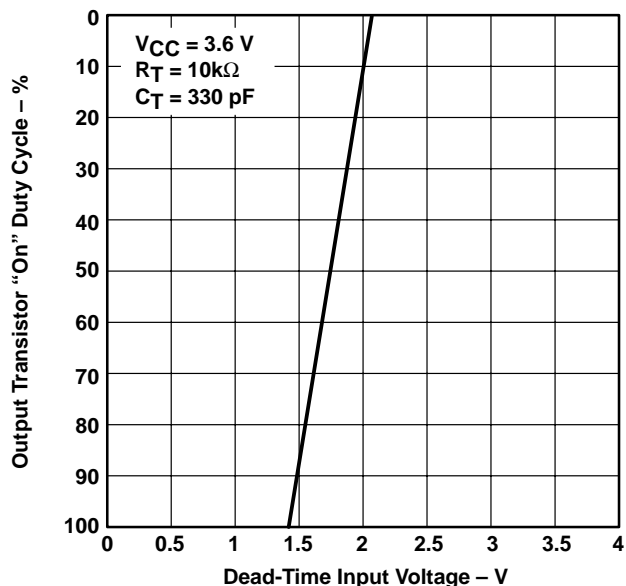

Figure 24

STANDBY CURRENT
vs
SUPPLY VOLTAGE

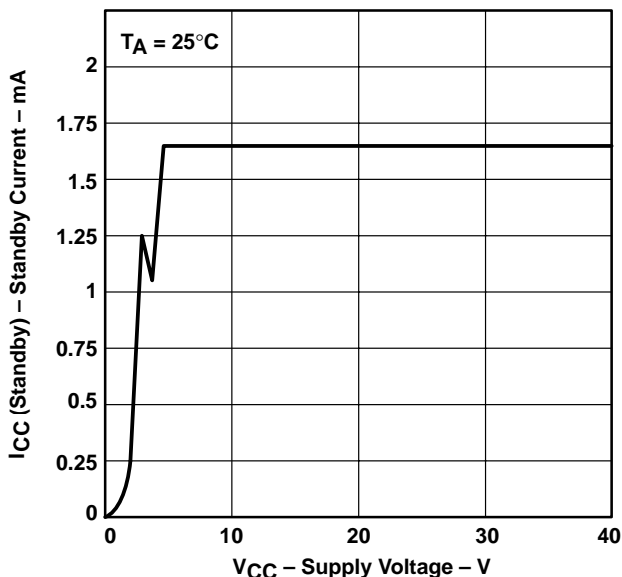

Figure 25

STANDBY CURRENT
vs
FREE-AIR TEMPERATURE

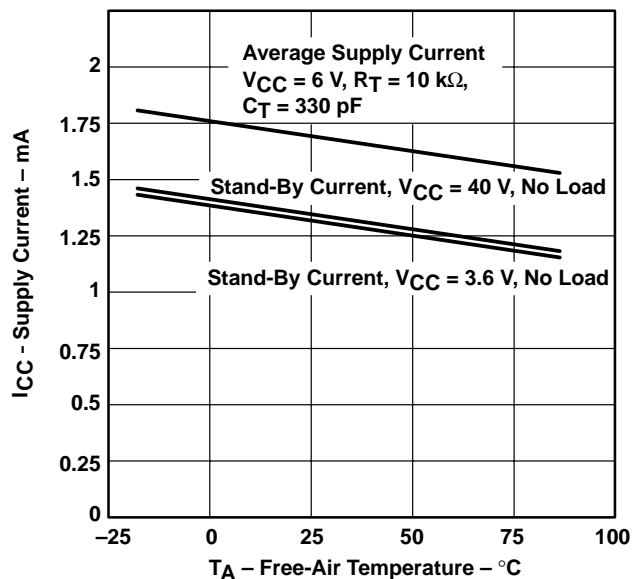

Figure 26

MAXIMUM CONTINUOUS POWER DISSIPATION
vs
FREE-AIR TEMPERATURE

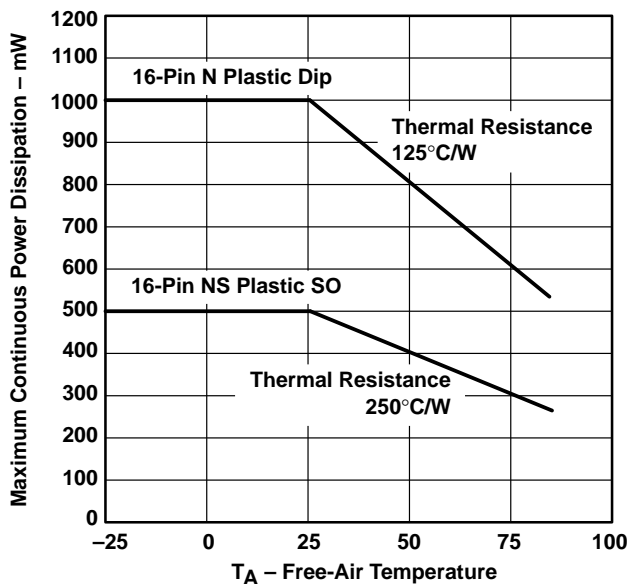
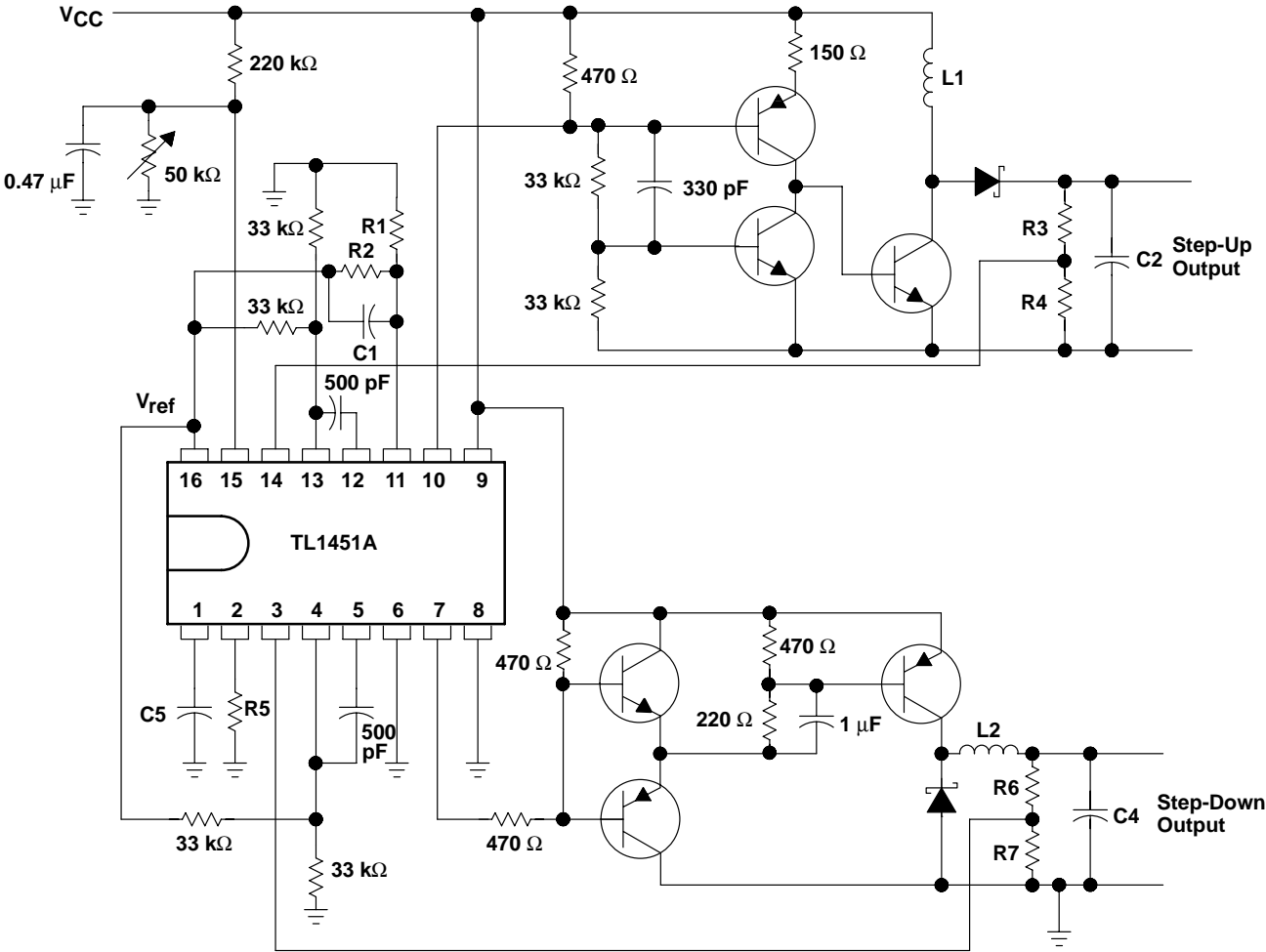

Figure 27

TL1451A DUAL PULSE-WIDTH-MODULATION CONTROL CIRCUITS

SLVS024E – FEBRUARY 1983 – REVISED NOVEMBER 1999

APPLICATION INFORMATION



NOTE A: Values for R1 through R7, C1 through C4, and L1 and L2 depend upon individual application.

Figure 28. High-Speed Dual Switching Regulator

PACKAGING INFORMATION

Orderable Device	Status (1)	Package Type	Package Drawing	Pins	Package Qty	Eco Plan (2)	Lead/Ball Finish (6)	MSL Peak Temp (3)	Op Temp (°C)	Device Marking (4/5)	Samples
5962-9958401Q2A	OBSOLETE	LCCC	FK	20		TBD	Call TI	Call TI	-55 to 125		
5962-9958401QEA	OBSOLETE	CDIP	J	16		TBD	Call TI	Call TI	-55 to 125		
TL1451ACD	ACTIVE	SOIC	D	16	40	Green (RoHS & no Sb/Br)	CU NIPDAU	Level-1-260C-UNLIM	-20 to 85	TL1451AC	Samples
TL1451ACDBLE	NRND	SSOP	DB	16		TBD	Call TI	Call TI	-20 to 85		
TL1451ACDBR	ACTIVE	SSOP	DB	16	2000	Green (RoHS & no Sb/Br)	CU NIPDAU	Level-1-260C-UNLIM	-20 to 85	T1451A	Samples
TL1451ACDBRG4	ACTIVE	SSOP	DB	16	2000	Green (RoHS & no Sb/Br)	CU NIPDAU	Level-1-260C-UNLIM	-20 to 85	T1451A	Samples
TL1451ACDG4	ACTIVE	SOIC	D	16	40	Green (RoHS & no Sb/Br)	CU NIPDAU	Level-1-260C-UNLIM	-20 to 85	TL1451AC	Samples
TL1451ACDR	ACTIVE	SOIC	D	16	2500	Green (RoHS & no Sb/Br)	CU NIPDAU	Level-1-260C-UNLIM	-20 to 85	TL1451AC	Samples
TL1451ACDRG4	ACTIVE	SOIC	D	16	2500	Green (RoHS & no Sb/Br)	CU NIPDAU	Level-1-260C-UNLIM	-20 to 85	TL1451AC	Samples
TL1451ACN	ACTIVE	PDIP	N	16	25	Pb-Free (RoHS)	CU NIPDAU	N / A for Pkg Type	-20 to 85	TL1451ACN	Samples
TL1451ACNE4	ACTIVE	PDIP	N	16		TBD	Call TI	Call TI	-20 to 85	TL1451ACN	Samples
TL1451ACNSR	ACTIVE	SO	NS	16	2000	Green (RoHS & no Sb/Br)	CU NIPDAU	Level-1-260C-UNLIM	-20 to 85	TL1451A	Samples
TL1451ACNSRG4	ACTIVE	SO	NS	16		TBD	Call TI	Call TI	-20 to 85	TL1451A	Samples
TL1451ACPW	ACTIVE	TSSOP	PW	16	90	Green (RoHS & no Sb/Br)	CU NIPDAU	Level-1-260C-UNLIM	-20 to 85	T1451A	Samples
TL1451ACPWG4	ACTIVE	TSSOP	PW	16	90	Green (RoHS & no Sb/Br)	CU NIPDAU	Level-1-260C-UNLIM	-20 to 85	T1451A	Samples
TL1451ACPWLE	OBSOLETE	TSSOP	PW	16		TBD	Call TI	Call TI	-20 to 85		
TL1451ACPWR	ACTIVE	TSSOP	PW	16	2000	Green (RoHS & no Sb/Br)	CU NIPDAU	Level-1-260C-UNLIM	-20 to 85	T1451A	Samples
TL1451ACPWRG4	ACTIVE	TSSOP	PW	16	2000	Green (RoHS & no Sb/Br)	CU NIPDAU	Level-1-260C-UNLIM	-20 to 85	T1451A	Samples
TL1451AMFKB	OBSOLETE	LCCC	FK	20		TBD	Call TI	Call TI	-55 to 125		
TL1451AMJB	OBSOLETE	CDIP	J	16		TBD	Call TI	Call TI	-55 to 125		

Orderable Device	Status (1)	Package Type	Package Drawing	Pins	Package Qty	Eco Plan (2)	Lead/Ball Finish (6)	MSL Peak Temp (3)	Op Temp (°C)	Device Marking (4/5)	Samples
TL1451AQD	ACTIVE	SOIC	D	16	40	Green (RoHS & no Sb/Br)	CU NIPDAU	Level-1-260C-UNLIM	-40 to 125	TL1451AQ	Samples
TL1451AQDG4	ACTIVE	SOIC	D	16	40	Green (RoHS & no Sb/Br)	CU NIPDAU	Level-1-260C-UNLIM		1451AQ	Samples
TL1451AQDR	ACTIVE	SOIC	D	16	2500	Green (RoHS & no Sb/Br)	CU NIPDAU	Level-1-260C-UNLIM	-40 to 125	TL1451AQ	Samples
TL1451AQDRG4	ACTIVE	SOIC	D	16	2500	Green (RoHS & no Sb/Br)	CU NIPDAU	Level-1-260C-UNLIM		1451AQ	Samples
TL1451CDBR	ACTIVE	SSOP	DB	16	2000	Green (RoHS & no Sb/Br)	CU NIPDAU	Level-1-260C-UNLIM		T1451	Samples
TL1451CDBRG4	ACTIVE	SSOP	DB	16		TBD	Call TI	Call TI		T1451	Samples
TL1451CN	ACTIVE	PDIP	N	16	25	Pb-Free (RoHS)	CU NIPDAU	N / A for Pkg Type		TL1451CN	Samples
TL1451CNE4	ACTIVE	PDIP	N	16		TBD	Call TI	Call TI		TL1451CN	Samples
TL1451CNS	ACTIVE	SO	NS	16	50	Green (RoHS & no Sb/Br)	CU NIPDAU	Level-1-260C-UNLIM		TL1451	Samples
TL1451CNSG4	ACTIVE	SO	NS	16	50	Green (RoHS & no Sb/Br)	CU NIPDAU	Level-1-260C-UNLIM		TL1451	Samples
TL1451CNSR	ACTIVE	SO	NS	16	2000	Green (RoHS & no Sb/Br)	CU NIPDAU	Level-1-260C-UNLIM		TL1451	Samples
TL1451CNSRG4	ACTIVE	SO	NS	16		TBD	Call TI	Call TI		TL1451	Samples
TL1451INSR	ACTIVE	SO	NS	16	2000	Green (RoHS & no Sb/Br)	CU NIPDAU	Level-1-260C-UNLIM		TL1451I	Samples
TL1451INSRG4	ACTIVE	SO	NS	16		TBD	Call TI	Call TI		TL1451I	Samples

(1) The marketing status values are defined as follows:

ACTIVE: Product device recommended for new designs.

LIFEBUY: TI has announced that the device will be discontinued, and a lifetime-buy period is in effect.

NRND: Not recommended for new designs. Device is in production to support existing customers, but TI does not recommend using this part in a new design.

PREVIEW: Device has been announced but is not in production. Samples may or may not be available.

OBSOLETE: TI has discontinued the production of the device.

(2) Eco Plan - The planned eco-friendly classification: Pb-Free (RoHS), Pb-Free (RoHS Exempt), or Green (RoHS & no Sb/Br) - please check <http://www.ti.com/productcontent> for the latest availability information and additional product content details.

TBD: The Pb-Free/Green conversion plan has not been defined.

Pb-Free (RoHS): TI's terms "Lead-Free" or "Pb-Free" mean semiconductor products that are compatible with the current RoHS requirements for all 6 substances, including the requirement that lead not exceed 0.1% by weight in homogeneous materials. Where designed to be soldered at high temperatures, TI Pb-Free products are suitable for use in specified lead-free processes.

Pb-Free (RoHS Exempt): This component has a RoHS exemption for either 1) lead-based flip-chip solder bumps used between the die and package, or 2) lead-based die adhesive used between the die and leadframe. The component is otherwise considered Pb-Free (RoHS compatible) as defined above.

Green (RoHS & no Sb/Br): TI defines "Green" to mean Pb-Free (RoHS compatible), and free of Bromine (Br) and Antimony (Sb) based flame retardants (Br or Sb do not exceed 0.1% by weight in homogeneous material)

⁽³⁾ MSL, Peak Temp. - The Moisture Sensitivity Level rating according to the JEDEC industry standard classifications, and peak solder temperature.

⁽⁴⁾ There may be additional marking, which relates to the logo, the lot trace code information, or the environmental category on the device.

⁽⁵⁾ Multiple Device Markings will be inside parentheses. Only one Device Marking contained in parentheses and separated by a "~" will appear on a device. If a line is indented then it is a continuation of the previous line and the two combined represent the entire Device Marking for that device.

⁽⁶⁾ Lead/Ball Finish - Orderable Devices may have multiple material finish options. Finish options are separated by a vertical ruled line. Lead/Ball Finish values may wrap to two lines if the finish value exceeds the maximum column width.

Important Information and Disclaimer: The information provided on this page represents TI's knowledge and belief as of the date that it is provided. TI bases its knowledge and belief on information provided by third parties, and makes no representation or warranty as to the accuracy of such information. Efforts are underway to better integrate information from third parties. TI has taken and continues to take reasonable steps to provide representative and accurate information but may not have conducted destructive testing or chemical analysis on incoming materials and chemicals. TI and TI suppliers consider certain information to be proprietary, and thus CAS numbers and other limited information may not be available for release.

In no event shall TI's liability arising out of such information exceed the total purchase price of the TI part(s) at issue in this document sold by TI to Customer on an annual basis.

OTHER QUALIFIED VERSIONS OF TL1451A, TL1451AM :

- Catalog: [TL1451A](#)
- Automotive: [TL1451A-Q1](#), [TL1451A-Q1](#)
- Enhanced Product: [TL1451A-EP](#), [TL1451A-EP](#)
- Military: [TL1451AM](#)

NOTE: Qualified Version Definitions:

- Catalog - TI's standard catalog product

- Automotive - Q100 devices qualified for high-reliability automotive applications targeting zero defects
- Enhanced Product - Supports Defense, Aerospace and Medical Applications
- Military - QML certified for Military and Defense Applications

TAPE AND REEL INFORMATION

QUADRANT ASSIGNMENTS FOR PIN 1 ORIENTATION IN TAPE

*All dimensions are nominal

Device	Package Type	Package Drawing	Pins	SPQ	Reel Diameter (mm)	Reel Width W1 (mm)	A0 (mm)	B0 (mm)	K0 (mm)	P1 (mm)	W (mm)	Pin1 Quadrant
TL1451ACDBR	SSOP	DB	16	2000	330.0	16.4	8.2	6.6	2.5	12.0	16.0	Q1
TL1451ACDR	SOIC	D	16	2500	330.0	16.4	6.5	10.3	2.1	8.0	16.0	Q1
TL1451ACDR	SOIC	D	16	2500	330.0	16.4	6.5	10.3	2.1	8.0	16.0	Q1
TL1451ACNSR	SO	NS	16	2000	330.0	16.4	8.2	10.5	2.5	12.0	16.0	Q1
TL1451ACPWR	TSSOP	PW	16	2000	330.0	12.4	6.9	5.6	1.6	8.0	12.0	Q1
TL1451AQDR	SOIC	D	16	2500	330.0	16.4	6.5	10.3	2.1	8.0	16.0	Q1
TL1451AQDRG4	SOIC	D	16	2500	330.0	16.4	6.5	10.3	2.1	8.0	16.0	Q1
TL1451CDBR	SSOP	DB	16	2000	330.0	16.4	8.2	6.6	2.5	12.0	16.0	Q1
TL1451CNSR	SO	NS	16	2000	330.0	16.4	8.2	10.5	2.5	12.0	16.0	Q1
TL1451INSR	SO	NS	16	2000	330.0	16.4	8.2	10.5	2.5	12.0	16.0	Q1

TAPE AND REEL BOX DIMENSIONS

*All dimensions are nominal

Device	Package Type	Package Drawing	Pins	SPQ	Length (mm)	Width (mm)	Height (mm)
TL1451ACDBR	SSOP	DB	16	2000	367.0	367.0	38.0
TL1451ACDR	SOIC	D	16	2500	333.2	345.9	28.6
TL1451ACDR	SOIC	D	16	2500	367.0	367.0	38.0
TL1451ACNSR	SO	NS	16	2000	367.0	367.0	38.0
TL1451ACPWR	TSSOP	PW	16	2000	367.0	367.0	35.0
TL1451AQDR	SOIC	D	16	2500	367.0	367.0	38.0
TL1451AQDRG4	SOIC	D	16	2500	367.0	367.0	38.0
TL1451CDBR	SSOP	DB	16	2000	367.0	367.0	38.0
TL1451CNSR	SO	NS	16	2000	367.0	367.0	38.0
TL1451INSR	SO	NS	16	2000	367.0	367.0	38.0

J (R-GDIP-T**)

14 LEADS SHOWN

CERAMIC DUAL IN-LINE PACKAGE



DIM \ PINS **	14	16	18	20
A	0.300 (7,62) BSC	0.300 (7,62) BSC	0.300 (7,62) BSC	0.300 (7,62) BSC
B MAX	0.785 (19,94)	.840 (21,34)	0.960 (24,38)	1.060 (26,92)
B MIN	—	—	—	—
C MAX	0.300 (7,62)	0.300 (7,62)	0.310 (7,87)	0.300 (7,62)
C MIN	0.245 (6,22)	0.245 (6,22)	0.220 (5,59)	0.245 (6,22)



4040083/F 03/03

- NOTES:
- A. All linear dimensions are in inches (millimeters).
 - B. This drawing is subject to change without notice.
 - C. This package is hermetically sealed with a ceramic lid using glass frit.
 - D. Index point is provided on cap for terminal identification only on press ceramic glass frit seal only.
 - E. Falls within MIL STD 1835 GDIP1-T14, GDIP1-T16, GDIP1-T18 and GDIP1-T20.

FK (S-CQCC-N**)

LEADLESS CERAMIC CHIP CARRIER

28 TERMINAL SHOWN



NO. OF TERMINALS **	A		B	
	MIN	MAX	MIN	MAX
20	0.342 (8,69)	0.358 (9,09)	0.307 (7,80)	0.358 (9,09)
28	0.442 (11,23)	0.458 (11,63)	0.406 (10,31)	0.458 (11,63)
44	0.640 (16,26)	0.660 (16,76)	0.495 (12,58)	0.560 (14,22)
52	0.740 (18,78)	0.761 (19,32)	0.495 (12,58)	0.560 (14,22)
68	0.938 (23,83)	0.962 (24,43)	0.850 (21,6)	0.858 (21,8)
84	1.141 (28,99)	1.165 (29,59)	1.047 (26,6)	1.063 (27,0)



4040140/D 01/11

- NOTES:
- All linear dimensions are in inches (millimeters).
 - This drawing is subject to change without notice.
 - This package can be hermetically sealed with a metal lid.
 - Falls within JEDEC MS-004

N (R-PDIP-T**)

PLASTIC DUAL-IN-LINE PACKAGE

16 PINS SHOWN



- NOTES:
- A. All linear dimensions are in inches (millimeters).
 - B. This drawing is subject to change without notice.
 - Falls within JEDEC MS-001, except 18 and 20 pin minimum body length (Dim A).
 - The 20 pin end lead shoulder width is a vendor option, either half or full width.

D (R-PDSO-G16)

PLASTIC SMALL OUTLINE



- NOTES:
- A. All linear dimensions are in inches (millimeters).
 - B. This drawing is subject to change without notice.
 - C. Body length does not include mold flash, protrusions, or gate burrs. Mold flash, protrusions, or gate burrs shall not exceed 0.006 (0,15) each side.
 - D. Body width does not include interlead flash. Interlead flash shall not exceed 0.017 (0,43) each side.
 - E. Reference JEDEC MS-012 variation AC.

D (R-PDSO-G16)

PLASTIC SMALL OUTLINE



- NOTES:
- A. All linear dimensions are in millimeters.
 - B. This drawing is subject to change without notice.
 - C. Publication IPC-7351 is recommended for alternate designs.
 - D. Laser cutting apertures with trapezoidal walls and also rounding corners will offer better paste release. Customers should contact their board assembly site for stencil design recommendations. Refer to IPC-7525 for other stencil recommendations.
 - E. Customers should contact their board fabrication site for solder mask tolerances between and around signal pads.

PW (R-PDSO-G16)

PLASTIC SMALL OUTLINE



4040064-4/G 02/11

- NOTES:
- A. All linear dimensions are in millimeters. Dimensioning and tolerancing per ASME Y14.5M-1994.
 - B. This drawing is subject to change without notice.
 -  Body length does not include mold flash, protrusions, or gate burrs. Mold flash, protrusions, or gate burrs shall not exceed 0,15 each side.
 -  Body width does not include interlead flash. Interlead flash shall not exceed 0,25 each side.
 - E. Falls within JEDEC MO-153

PW (R-PDSO-G16)

PLASTIC SMALL OUTLINE

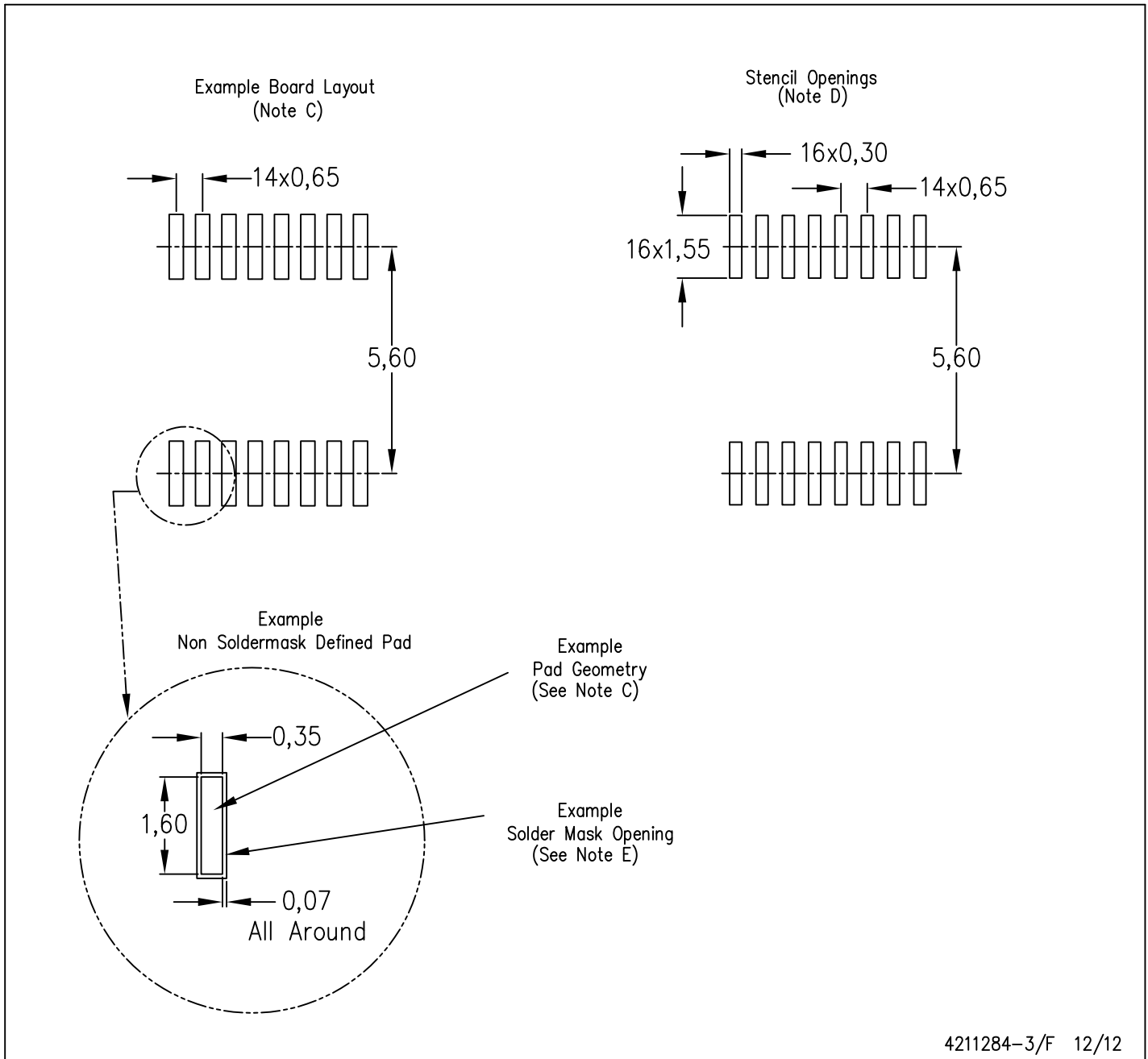

- NOTES:
- All linear dimensions are in millimeters.
 - This drawing is subject to change without notice.
 - Publication IPC-7351 is recommended for alternate designs.
 - Laser cutting apertures with trapezoidal walls and also rounding corners will offer better paste release. Customers should contact their board assembly site for stencil design recommendations. Refer to IPC-7525 for other stencil recommendations.
 - Customers should contact their board fabrication site for solder mask tolerances between and around signal pads.

DB (R-PDSO-G**)

PLASTIC SMALL-OUTLINE

28 PINS SHOWN



- NOTES: A. All linear dimensions are in millimeters.
 B. This drawing is subject to change without notice.
 C. Body dimensions do not include mold flash or protrusion not to exceed 0,15.
 D. Falls within JEDEC MO-150

MECHANICAL DATA

NS (R-PDSO-G**)

PLASTIC SMALL-OUTLINE PACKAGE

14-PINS SHOWN



- NOTES:
- A. All linear dimensions are in millimeters.
 - B. This drawing is subject to change without notice.
 - C. Body dimensions do not include mold flash or protrusion, not to exceed 0,15.

IMPORTANT NOTICE

Texas Instruments Incorporated and its subsidiaries (TI) reserve the right to make corrections, enhancements, improvements and other changes to its semiconductor products and services per JESD46, latest issue, and to discontinue any product or service per JESD48, latest issue. Buyers should obtain the latest relevant information before placing orders and should verify that such information is current and complete. All semiconductor products (also referred to herein as "components") are sold subject to TI's terms and conditions of sale supplied at the time of order acknowledgment.

TI warrants performance of its components to the specifications applicable at the time of sale, in accordance with the warranty in TI's terms and conditions of sale of semiconductor products. Testing and other quality control techniques are used to the extent TI deems necessary to support this warranty. Except where mandated by applicable law, testing of all parameters of each component is not necessarily performed.

TI assumes no liability for applications assistance or the design of Buyers' products. Buyers are responsible for their products and applications using TI components. To minimize the risks associated with Buyers' products and applications, Buyers should provide adequate design and operating safeguards.

TI does not warrant or represent that any license, either express or implied, is granted under any patent right, copyright, mask work right, or other intellectual property right relating to any combination, machine, or process in which TI components or services are used. Information published by TI regarding third-party products or services does not constitute a license to use such products or services or a warranty or endorsement thereof. Use of such information may require a license from a third party under the patents or other intellectual property of the third party, or a license from TI under the patents or other intellectual property of TI.

Reproduction of significant portions of TI information in TI data books or data sheets is permissible only if reproduction is without alteration and is accompanied by all associated warranties, conditions, limitations, and notices. TI is not responsible or liable for such altered documentation. Information of third parties may be subject to additional restrictions.

Resale of TI components or services with statements different from or beyond the parameters stated by TI for that component or service voids all express and any implied warranties for the associated TI component or service and is an unfair and deceptive business practice. TI is not responsible or liable for any such statements.

Buyer acknowledges and agrees that it is solely responsible for compliance with all legal, regulatory and safety-related requirements concerning its products, and any use of TI components in its applications, notwithstanding any applications-related information or support that may be provided by TI. Buyer represents and agrees that it has all the necessary expertise to create and implement safeguards which anticipate dangerous consequences of failures, monitor failures and their consequences, lessen the likelihood of failures that might cause harm and take appropriate remedial actions. Buyer will fully indemnify TI and its representatives against any damages arising out of the use of any TI components in safety-critical applications.

In some cases, TI components may be promoted specifically to facilitate safety-related applications. With such components, TI's goal is to help enable customers to design and create their own end-product solutions that meet applicable functional safety standards and requirements. Nonetheless, such components are subject to these terms.

No TI components are authorized for use in FDA Class III (or similar life-critical medical equipment) unless authorized officers of the parties have executed a special agreement specifically governing such use.

Only those TI components which TI has specifically designated as military grade or "enhanced plastic" are designed and intended for use in military/aerospace applications or environments. Buyer acknowledges and agrees that any military or aerospace use of TI components which have *not* been so designated is solely at the Buyer's risk, and that Buyer is solely responsible for compliance with all legal and regulatory requirements in connection with such use.

TI has specifically designated certain components as meeting ISO/TS16949 requirements, mainly for automotive use. In any case of use of non-designated products, TI will not be responsible for any failure to meet ISO/TS16949.

Products

Audio	www.ti.com/audio
Amplifiers	amplifier.ti.com
Data Converters	dataconverter.ti.com
DLP® Products	www.dlp.com
DSP	dsp.ti.com
Clocks and Timers	www.ti.com/clocks
Interface	interface.ti.com
Logic	logic.ti.com
Power Mgmt	power.ti.com
Microcontrollers	microcontroller.ti.com
RFID	www.ti-rfid.com
OMAP Applications Processors	www.ti.com/omap
Wireless Connectivity	www.ti.com/wirelessconnectivity

Applications

Automotive and Transportation	www.ti.com/automotive
Communications and Telecom	www.ti.com/communications
Computers and Peripherals	www.ti.com/computers
Consumer Electronics	www.ti.com/consumer-apps
Energy and Lighting	www.ti.com/energy
Industrial	www.ti.com/industrial
Medical	www.ti.com/medical
Security	www.ti.com/security
Space, Avionics and Defense	www.ti.com/space-avionics-defense
Video and Imaging	www.ti.com/video

TI E2E Community

e2e.ti.com